



### General Description

The TP6312 is a VFD (Vacuum Fluorescent Display) controller/driver that is driven on a 1/4 to 1/11-duty factor. It consists of 11 segment output lines, 6 grid output lines, 5 segment/grid output drivelines, a display memory, a control circuit, and a Key scan circuit. Serial data is input to TP6312 through a three-line serial interface. This VFD controller/driver is ideal as a peripheral device of a single-chip microcomputer.

### Features

- Multiple display modes (11-segment & 11-digit to 16-segment & 4-digit)
- Key scanning (6 × 4 matrices)
- Dimming circuit (eight steps)
- High-voltage output ( $V_{DD} - 35V$  max)
- LED ports (4 chs, 20 mA max)
- General-purpose input port (4 bits)
- No external resistor necessary for driver outputs (P-ch open-drain + pull-down resistor output)
- Serial interface (CLK, STB,  $D_{IN}$ ,  $D_{OUT}$ )

### Ordering Information

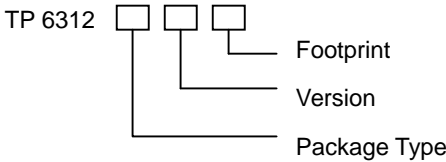

<b>Package Type</b>	F: LQFP
<b>Footprint</b>	S: 2.0 mm L: 3.2 mm

### Block Diagram

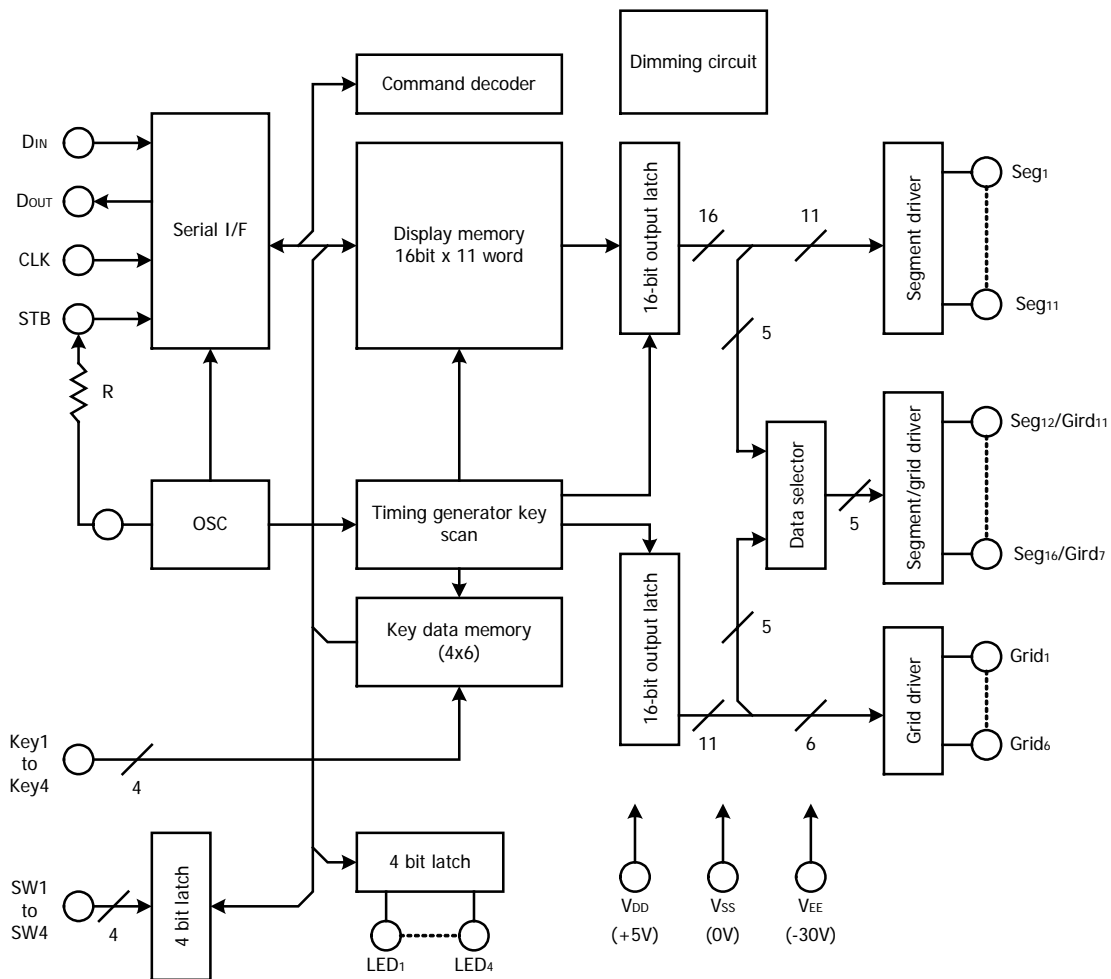



Pin Configuration (Top View)

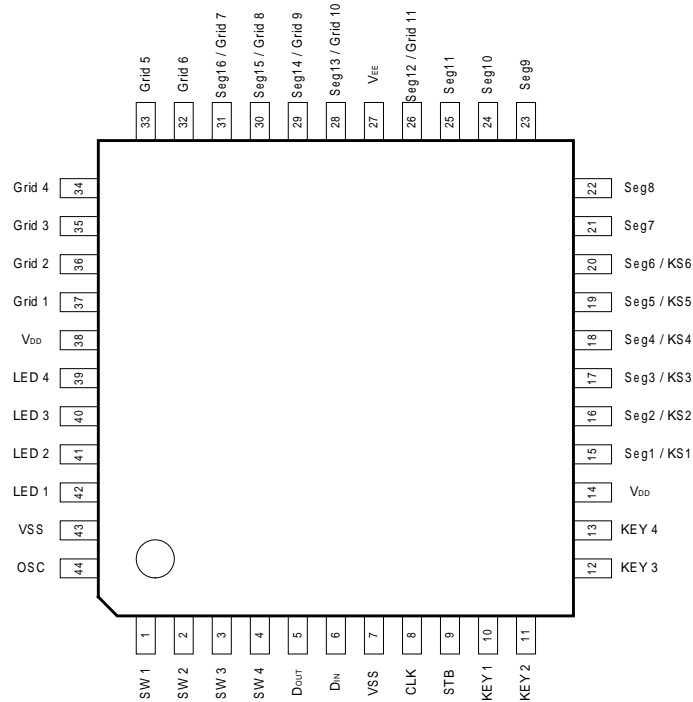

Use all the power pins.

Pin Description

Pin No	Symbol	Pin Name	Description
6	D <sub>IN</sub>	Date input	Inputs serial data at rising edge of shift clock, starting from the lower bit.
5	D <sub>OUT</sub>	Date output	Outputs serial data at falling edge of shift clock, starting from the lower bit. This is N-ch open-drain output pin.
9	STB	Strobe	Initializes the serial interface at rising or falling edge to make TP6312 waiting for reception of command. Data input after STB has fallen is processed as command. While command data is processed, current processing is stopped and serial interface is initialized. While STB is high, CLK is ignored.
8	CLK	Clock input	Reads serial data at rising edge, and outputs data at falling edge.
44	OSC	Oscillator pin	Connects a resistor to this pin to determine the oscillation frequency to this pin.
15 to 20	Seg <sub>1</sub> /KS <sub>1</sub> to Seg <sub>6</sub> /KS <sub>6</sub>	High-voltage output	Segment output pins (Dual function as Key source).
21 to 25	Seg <sub>7</sub> to Seg <sub>11</sub>	High-voltage output (Segment)	Segment output pins.
37 to 32	Grid <sub>1</sub> to Grid <sub>6</sub>	High-voltage output (Grid)	Grid output pins.
26, 28 to 31	Seg <sub>11</sub> /Grid <sub>11</sub> to Seg <sub>16</sub> /Grid <sub>7</sub>	High-voltage output (Segment/grid)	These pins are selectable for segment or grid driving.
42 to 39	LED <sub>1</sub> to LED <sub>4</sub>	LED output	CMOS output. +20 mA max.
10 to 13	Key <sub>1</sub> to Key <sub>4</sub>	Key data input	Data input to these pins is latched at the end of display cycle.
1 to 4	SW <sub>1</sub> to SW <sub>4</sub>	Switch input	These pins constitute 4-bit general-purpose input port.
14, 38	V <sub>DD</sub>	Logic power	5V ± 10%
7, 43	V <sub>SS</sub>	Logic ground	Connect this pin to system GND.
27	V <sub>EE</sub>	Pull-down level	V <sub>DD</sub> – 35 V max



### Functional Description

#### Display RAM Address and Display Mode

The display RAM stores the data transmitted from an external device to TP6312 through the serial interface, and is assigned addresses as follows, in units of 8 bits:

Seg <sub>1</sub>	Seg <sub>4</sub>	Seg <sub>8</sub>	Seg <sub>12</sub>	Seg <sub>16</sub>	
00H <sub>L</sub>	00H <sub>U</sub>	01H <sub>L</sub>	01H <sub>U</sub>		DIG1
02H <sub>L</sub>	02H <sub>U</sub>	03H <sub>L</sub>	03H <sub>U</sub>		DIG2
04H <sub>L</sub>	04H <sub>U</sub>	05H <sub>L</sub>	05H <sub>U</sub>		DIG3
06H <sub>L</sub>	06H <sub>U</sub>	07H <sub>L</sub>	07H <sub>U</sub>		DIG4
08H <sub>L</sub>	08H <sub>U</sub>	09H <sub>L</sub>	09H <sub>U</sub>		DIG5
0AH <sub>L</sub>	0AH <sub>U</sub>	0BH <sub>L</sub>	0BH <sub>U</sub>		DIG6
0CH <sub>L</sub>	0CH <sub>U</sub>	0DH <sub>L</sub>	0DH <sub>U</sub>		DIG7
0EH <sub>L</sub>	0EH <sub>U</sub>	0FH <sub>L</sub>	0FH <sub>U</sub>		DIG8
10H <sub>L</sub>	10H <sub>U</sub>	11H <sub>L</sub>	11H <sub>U</sub>		DIG9
12H <sub>L</sub>	12H <sub>U</sub>	13H <sub>L</sub>	13H <sub>U</sub>		DIG10
14H <sub>L</sub>	14H <sub>U</sub>	15H <sub>L</sub>	15H <sub>U</sub>		DIG11

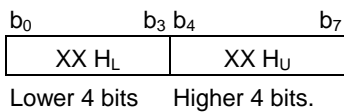

#### Key Matrix and Key-Input Data Storage RAM

The Key matrix is of 6 × 4 configuration, as shown below.

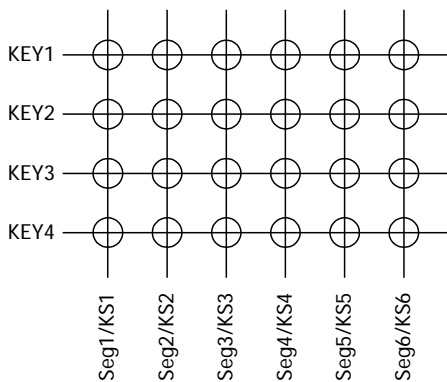

The data of each Key is stored as illustrated below, and is read by a read command, starting from the least significant bit.

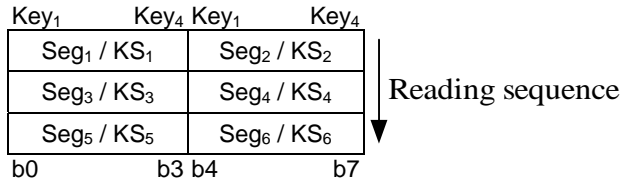

#### LED Port

Data is written to the LED port by a write command, starting from the least significant bit of the port. When a bit of this port is 0, the corresponding LED lights; when the bit is 1, the LED goes off. The data of bits 5 through 8 is ignored.

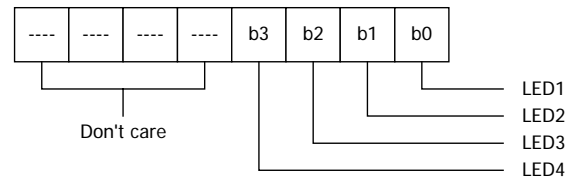

On power application, all LEDs are unlit.

#### SW Data

The SW data is read by a read command, starting from the least significant bit. Bits 5 through 8 of the SW data are 0.

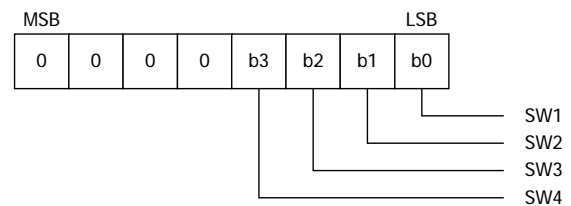

#### Commands

A command sets the display mode and status of the VFD driver.

The first 1 byte input to TP6312 through the D<sub>IN</sub> pin after the STB pin has fallen is regarded as a command.

If STB is high while a command/data is transmitted, serial communication is initialized, and the transmitting command/data is invalid; however, the



command/data already transmitted remains valid.

### (1) Display mode setting command

This command initializes TP6312 and selects the number of segments and number of grids (1/4 to 1/11-duty, 11 segments to 16 segments).

On power application, the 11-digit, 11-segment mode is selected.

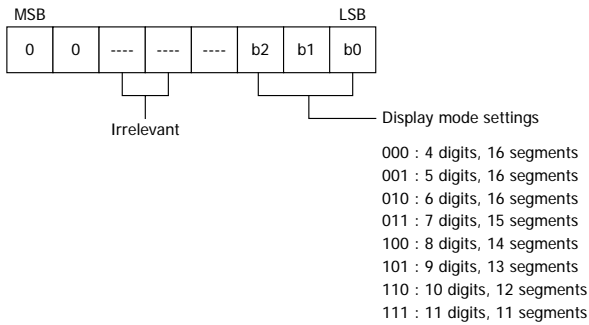

If address 16H or higher is set, the data is ignored and unit a correct address is set.

On power application, the address is set to 00H.

### (4) Display control command

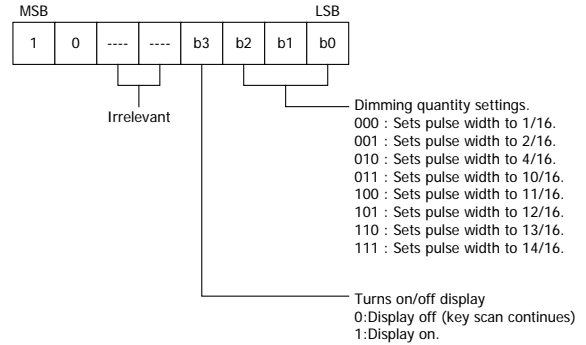

On power application, the 14/16-pulse width is set and the display is turned off.

### (2) Data setting commands

This command sets data write and read modes.

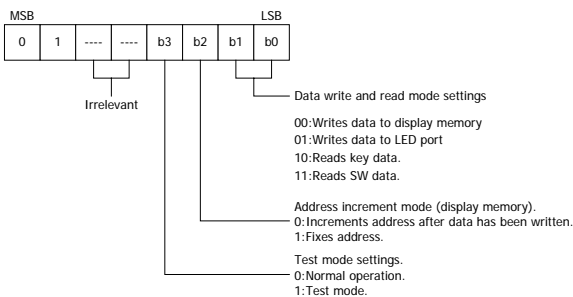

On power application, the normal operation mode and address increment mode set.

### (3) Address setting command

This command sets an address of the display memory.

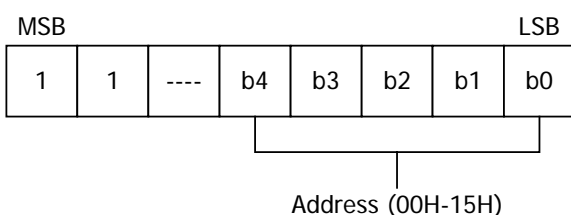

### Key Scanning and Display Timing

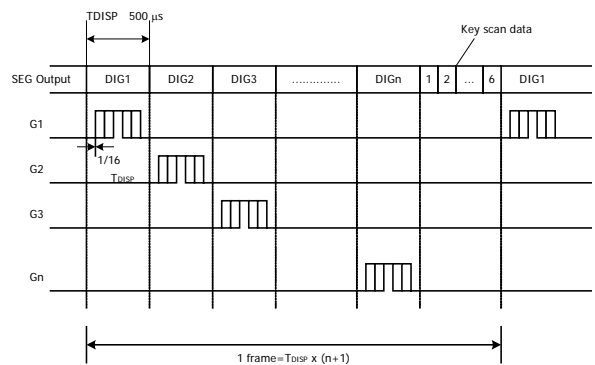

One cycle of Key scanning consists of two frames, and data of 6 × 4 matrices is stored in RAM.

### Serial Communication Format

#### Reception (command/data write)

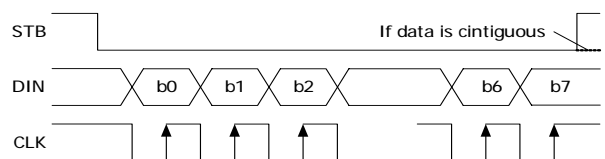



### Transmission (data read)

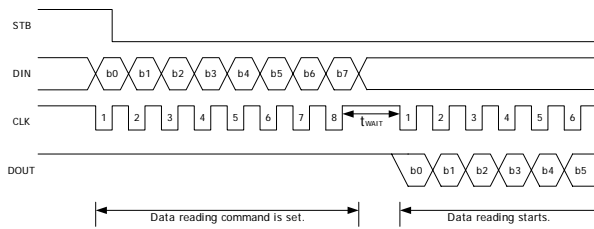

Because the D<sub>OUT</sub> pin is an N-ch open-drain output pin, be sure to connect an external pull-up resistor to this pin (1kΩ to 10 kΩ).

\*: When data is read, a wait time ( $t_{WAIT}$ ) of 1μs is necessary from the rising of the eighth clock that has set the command till the falling of the first clock that has read the data.

### Absolute Maximum Ratings (Ta = 25°C, V<sub>SS</sub> = 0V)

Parameter	Symbol	Ratings	Unit
Logic Supply Voltage	V <sub>DD</sub>	-0.5 to +7.0	V
Driver Supply Voltage	V <sub>EE</sub>	V <sub>DD</sub> +0.5 to V <sub>DD</sub> -40	V
Logic Input Voltage	V <sub>I1</sub>	-0.5 to V <sub>DD</sub> +0.5	V
VFD Driver Output Voltage	V <sub>O2</sub>	V <sub>EE</sub> -0.5 to V <sub>DD</sub> +0.5	V
LED Driver Output Current	I <sub>o1</sub>	+25	mA
VFD Driver Output Current	I <sub>o2</sub>	-40 (grid) -15 (segment)	mA
Power Dissipation	P <sub>D</sub>	800	mW
Operating Ambient Temperature	T <sub>opt</sub>	-40 to +70	
Storage Temperature	T <sub>stg</sub>	-65 to +150	

\* Derate at -6.4 mW/ at Ta = 25 or higher.

### Recommended Operating Conditions (Ta = -20°C to +70°C, V<sub>SS</sub> = 0V)

Parameter	Symbol	Min.	Typ.	Max.	Unit	Test Condition
Logic Supply Voltage	V <sub>DD</sub>	4.5	5	5.5	V	
High-Level input Voltage	V <sub>IH</sub>	0.7V <sub>DD</sub>		V <sub>DD</sub>	V	
Low-Level input Voltage	V <sub>IL</sub>	0		0.3V <sub>DD</sub>	V	
Driver Supply Voltage	V <sub>EE</sub>	0		V <sub>DD</sub> -35	V	

Maximum power consumption P<sub>MAX</sub> = VFD driver dissipation + R<sub>L</sub> dissipation + LED driver dissipation + dynamic power consumption.

Where segment current = 3 mA, grid current = 15mA, and LED current = 20 mA,

VFD driver dissipation = number of segments x 6 + number of grids/(number of grids + 1) x 30(mW)

R<sub>L</sub> dissipation (V<sub>DD</sub>-V<sub>EE</sub>)<sup>2</sup>/50 x (segment+1) (mW)

LED driver dissipation = number of LEDs x 20(mW)

Dynamic power consumption = V<sub>DD</sub> x 5(mW)

### Electrical Characteristics (Ta = -20°C to +70°C, V<sub>DD</sub> = 4.5V to 5.5V, V<sub>S</sub> = 0V, V<sub>EE</sub> = V<sub>DD</sub> - 35V)

Parameter	Symbol	Min	Typ.	Max.	Unit	Test Conditions
High-Level Output Voltage	V <sub>OH1</sub>	0.9 V <sub>DD</sub>			V	LED <sub>1</sub> – LED <sub>4</sub> , I <sub>OH1</sub> = -1 mA
Low-Level Output Voltage	V <sub>OL1</sub>			1	V	LED <sub>1</sub> – LED <sub>4</sub> , I <sub>OL1</sub> = 20 mA
Low-Level Output Voltage	V <sub>OL2</sub>			0.4	V	D <sub>OUT</sub> , I <sub>OL2</sub> = 4 mA
High-Level Output Current	I <sub>OH21</sub>	-3			mA	V <sub>O</sub> = V <sub>DD</sub> -2V, Seg <sub>1</sub> to Seg <sub>11</sub>
High-Level Output Current	I <sub>OH22</sub>	-15			mA	V <sub>O</sub> = V <sub>DD</sub> -2V, Grid <sub>1</sub> to Grid <sub>6</sub> , Seg <sub>12</sub> /Seg <sub>11</sub> to Seg <sub>16</sub> /Seg <sub>7</sub>
Driver Leakage Current	I <sub>OLEAK</sub>			-10	μA	V <sub>O</sub> = V <sub>DD</sub> - 35V, Drive off
Output Pull-Down Resistor	R <sub>L</sub>	50	100	150	kΩ	Drive output
Input Current	I <sub>i</sub>			±1	μA	V <sub>I</sub> = V <sub>DD</sub> or V <sub>SS</sub>
High-Level Input Voltage	V <sub>IH</sub>	0.6 V <sub>DD</sub>			V	
Low-Level Input Voltage	V <sub>IL</sub>			0.3 V <sub>DD</sub>	V	
Hysteresis Voltage	V <sub>H</sub>		0.35		V	CLK, D <sub>IN</sub> , STB
Dynamic Current Consumption	I <sub>DDdyn</sub>			5	mA	Under no load, display off



# TP6312

## 1/4 TO 1/11-DUTY VFD CONTROLLER/DRIVER

Switching Characteristics ( $T_a = -20^{\circ}\text{C}$  to  $+70^{\circ}\text{C}$ ,  $V_{DD} = 4.5\text{V}$  to  $5.5\text{V}$ ,  $V_{EE} = -30\text{V}$ )

Parameter	Symbol	Min	Typ.	Max.	Unit	Test Conditions
Oscillation Frequency	$f_{OSC}$	350	500	650	kHz	$R = 56\text{k}\Omega$
Propagation Delay Time	$t_{PLZ}$			300	ns	CLK $\Rightarrow$ DOUT CL = 15pF, RL = 10k $\Omega$
	$t_{PZL}$			100	ns	
Rise Time	$t_{TZH1}$			2	$\mu\text{s}$	CL = 300 PF Seg1 to Seg11 Grid1 to Grid6 Seg12/Grid11 to Seg16/Grid7
	$t_{TZH2}$			0.5	$\mu\text{s}$	
Fall Time	$t_{THZ}$			120	$\mu\text{s}$	CL = 300 pF, Segn, Gridn
Maximum Clock Frequency	$f_{max}$	1			MHz	Duty = 50%
Input Capacitance	C1			15	pF	

Timing Conditions ( $T_a = -20^{\circ}\text{C}$  to  $+70^{\circ}\text{C}$ ,  $V_{dd} = 4.5\text{V}$  to  $5.5\text{V}$ )

Parameter	Symbol	Min	Typ.	Max.	Unit	Test Conditions
Clock Pulse Width	PWCLK	400			ns	
Strobe Pulse Width	PWSTB	1			$\mu\text{s}$	
Data Setup Time	$t_{SETUP}$	100			ns	
Data Hold Time	$t_{HOLD}$	100			ns	
Clock-Strobe Time	$t_{CLK-STB}$	1			$\mu\text{s}$	CLK STB
Wait Time	$t_{WAIT}$	1			$\mu\text{s}$	CLK CLK

### Switching Characteristic Waveform

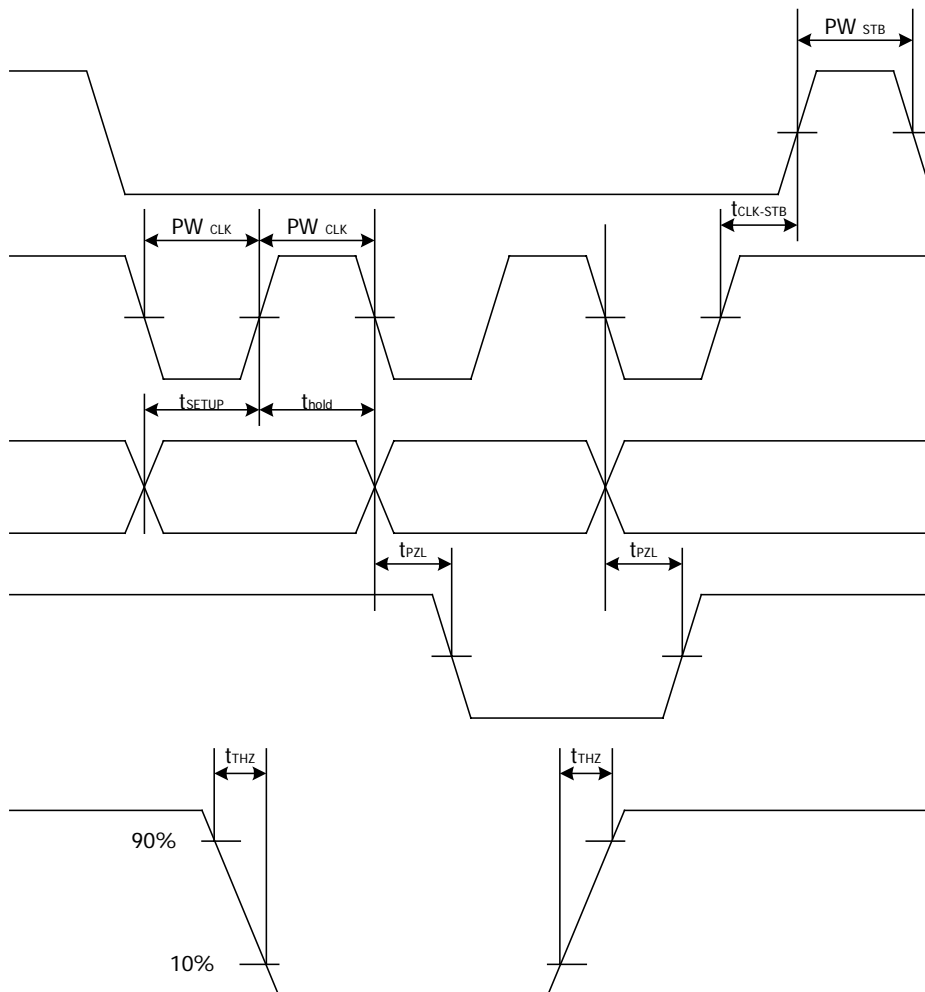



### Application

#### Updating display memory by incrementing address

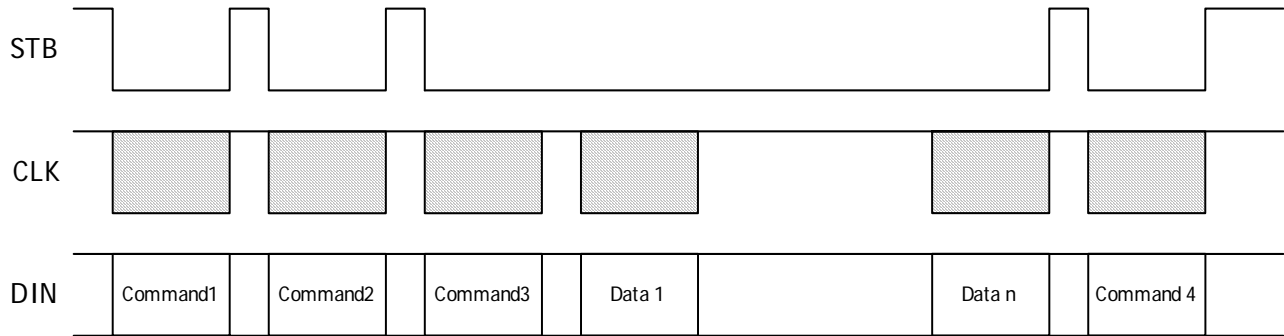

- Command1: sets display mode
- Command2: sets data
- Command3: sets address
- Data 1 to n: transfers display data (22 bytes max.)
- Command4: controls display

#### Updating specific address

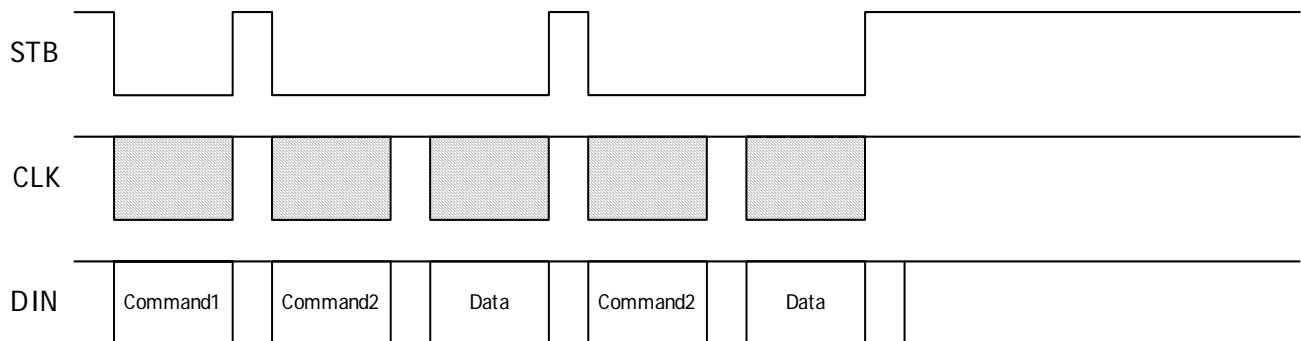

- Command1: sets data
- Command2: sets address
- Data: display data



Package Information

44-Pin Plastic LQFP Short-Lead (Footprint = 2.0mm)

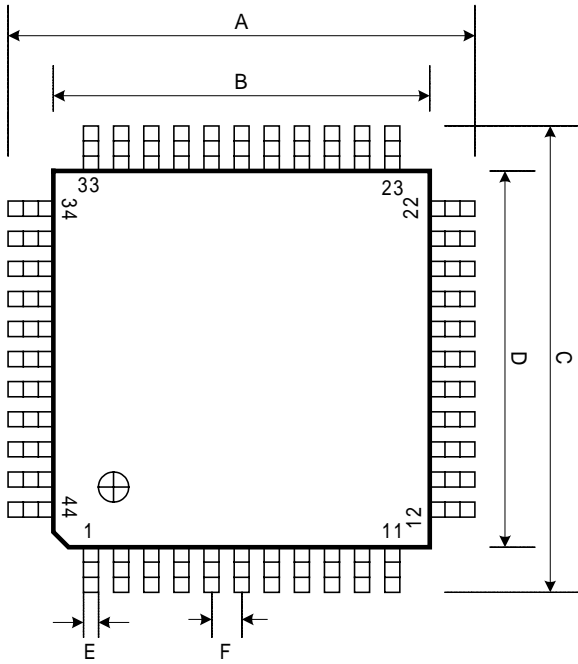

NOTE

Each lead centerline is located within 0.16 mm of its true position (T.P.) at maximum material

(Unit: mm)

Item	Millimeters
A	12.0 ± 0.2
B	10.0 ± 0.2
C	12.0 ± 0.2
D	10.0 ± 0.2
E	0.37(TYP.)
F	0.8 BSC
G	0.3 <sup>+0.2</sup> <sub>-0.1</sub>
H	1.0
I	0.6 ± 0.15
J	12° ± 1°
K	12° ± 1°
L	1.7 MAX
M	1.4 ± 0.1
N	0° MIN
O	+3° <sup>+7°</sup> <sub>-3°</sub>

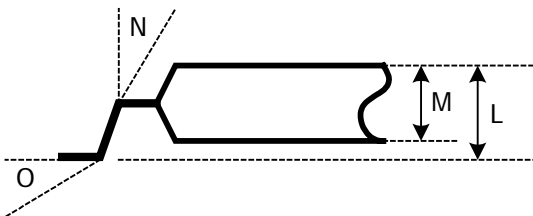
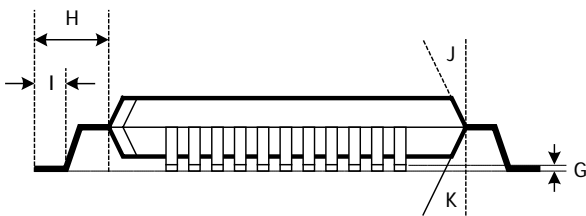





# TP6312

## 1/4 TO 1/11-DUTY VFD CONTROLLER/DRIVER

44-Pin Plastic LQFP Long-Lead (Footprint = 3.2mm)

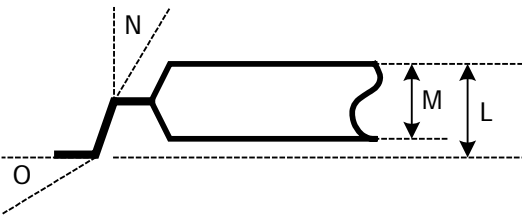
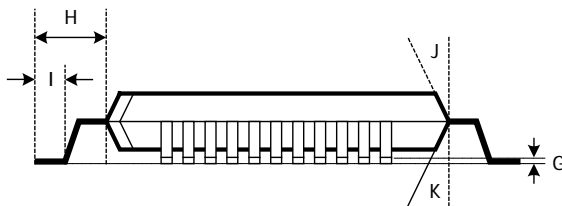
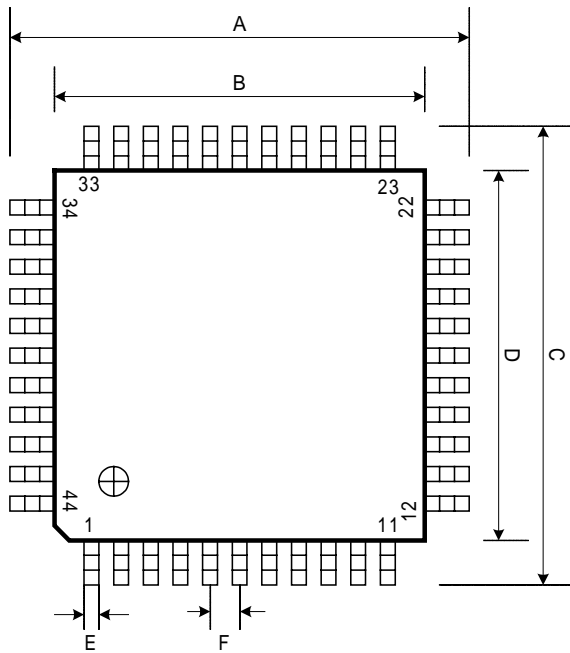

### NOTE

Each lead centerline is located within 0.16 mm of its true position (T.P.) at maximum material

(Unit: mm)

Item	Millimeters
A	13.2 ± 0.2
B	10.0 ± 0.2
C	13.2 ± 0.2
D	10.0 ± 0.2
E	0.37(TYP.)
F	0.8 BSC
G	0.3 +0.2 -0.1
H	1.6
I	1.2 ± 0.15
J	12° ± 1°
K	12° ± 1°
L	1.7 MAX
M	1.4 ± 0.1
N	0° MIN
O	+3° +7° -3°

### Topro Technology Inc.

#### Headquarters

5 F, No. 10, Prosperity Road 1, Science-Based Industrial Park, Hsinchu 300, Taiwan, R.O.C  
Tel.: 886-3-563-2515 Fax: 886-3-564-1728

#### Taipei Office

5 F, No.27, Min Chuan W. Rd. Taipei 104, Taiwan, R.O.C  
Tel.: 886-2-2585-6858 Fax: 886-2-2594-1104

#### Shenzhen Office

Room 802, Tower A, World Trade Plaza, Fahong Rd., Fatian, Shenzhen, China  
Tel.: 86-755-8367-9985 Fax: 86-755-8367-9518