

## TI PanelBus™ DIGITAL RECEIVER

Check for Samples: [TFP401](#), [TFP401A](#)

### FEATURES

- Supports Pixel Rates Up to 165 MHz (Including 1080p and WUXGA at 60 Hz)
- Digital Visual Interface (DVI) Specification Compliant <sup>(1)</sup>
- True-Color, 24-Bit/Pixel, 16.7M Colors at 1 or 2 Pixels per Clock
- Laser Trimmed Internal Termination Resistors for Optimum Fixed Impedance Matching
- Skew Tolerant Up to One Pixel-Clock Cycle
- 4× Oversampling
- Reduced Power Consumption – 1.8-V Core Operation With 3.3-V I/Os and Supplies <sup>(2)</sup>
- Reduced Ground Bounce Using Time-Staggered Pixel Outputs
- Low Noise and Good Power Dissipation Using TI PowerPAD™ Packaging
- Advanced Technology Using TI 0.18-μm EPIC-5™ CMOS Process
- TFP401A Incorporates HSYNC Jitter Immunity <sup>(3)</sup>

- (1) The Digital Visual Interface Specification, DVI, is an industry standard developed by the Digital Display Working Group (DDWG) for high-speed digital connection to digital displays. The TFP401 and TFP401A are compliant with the DVI Specification Rev. 1.0.
- (2) The TFP401/401A has an internal voltage regulator that provides the 1.8-V core power supply from the external 3.3-V supplies.
- (3) The TFP401A incorporates additional circuitry to create a stable HSYNC from DVI transmitters that introduce undesirable jitter on the transmitted HSYNC signal.

### DESCRIPTION

The Texas Instruments TFP401 and TFP401A are TI *PanelBus*™ flat-panel display products, part of a comprehensive family of end-to-end DVI 1.0 compliant solutions. Targeted primarily at desktop LCD monitors and digital projectors, the TFP401/401A finds applications in any design requiring high-speed digital interface.

The TFP401/401A supports display resolutions up to 1080p and WUXGA in 24-bit true-color pixel format. The TFP401/401A offers design flexibility to drive one or two pixels per clock, supports TFT or DSTN panels, and provides an option for time-staggered pixel outputs for reduced ground bounce.

PowerPAD advanced packaging technology results in best-of-class power dissipation, footprint, and ultralow ground inductance.

The TFP401/401A combines *PanelBus* circuit innovation with TI's advanced 0.18-μm EPIC-5™ CMOS process technology, along with TI PowerPAD package technology to achieve a reliable, low-powered, low-noise, high-speed digital interface solution.

### AVAILABLE OPTIONS

T <sub>A</sub>	PACKAGED DEVICE
	100-TQFP (PZP)
0°C to 70°C	TFP401PZP
	TFP401APZP



Please be aware that an important notice concerning availability, standard warranty, and use in critical applications of Texas Instruments semiconductor products and disclaimers thereto appears at the end of this data sheet.

*PanelBus*, PowerPAD, EPIC-5 are trademarks of Texas Instruments.

100-PIN PACKAGE  
(TOP VIEW)

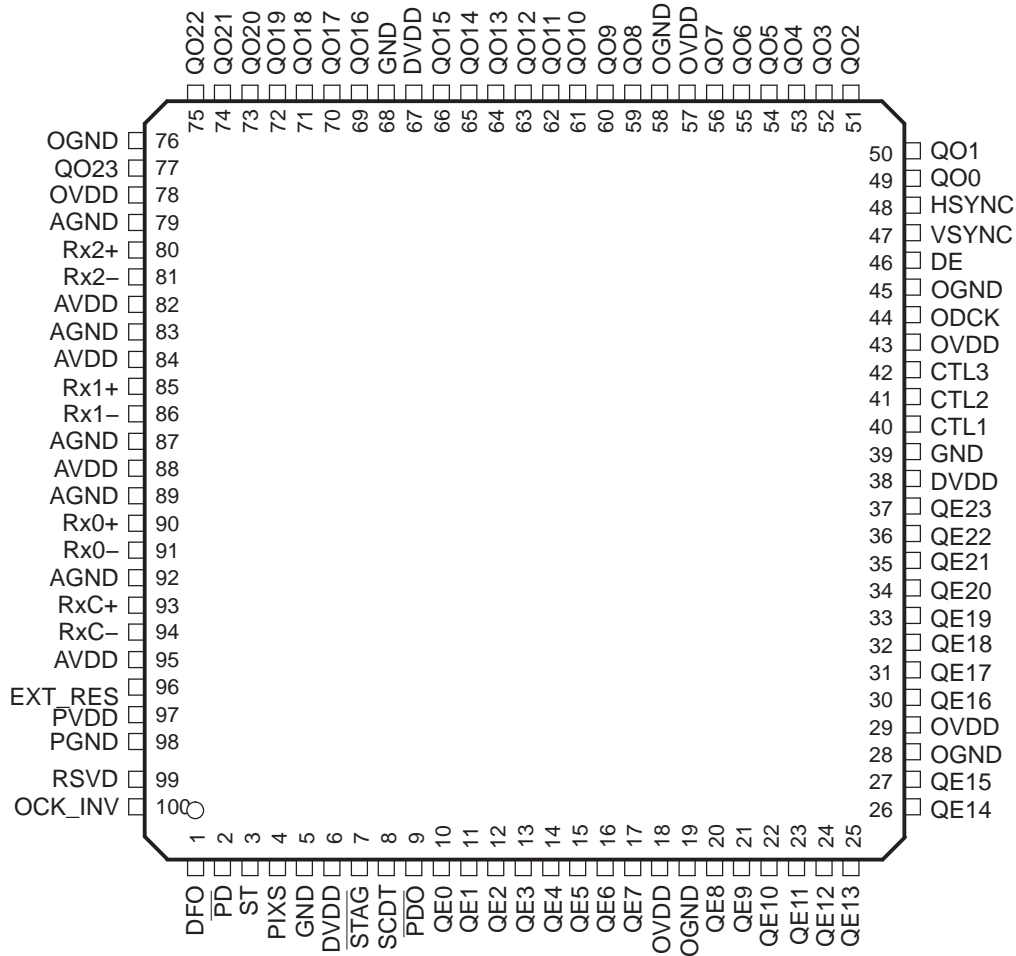

FUNCTIONAL BLOCK DIAGRAM

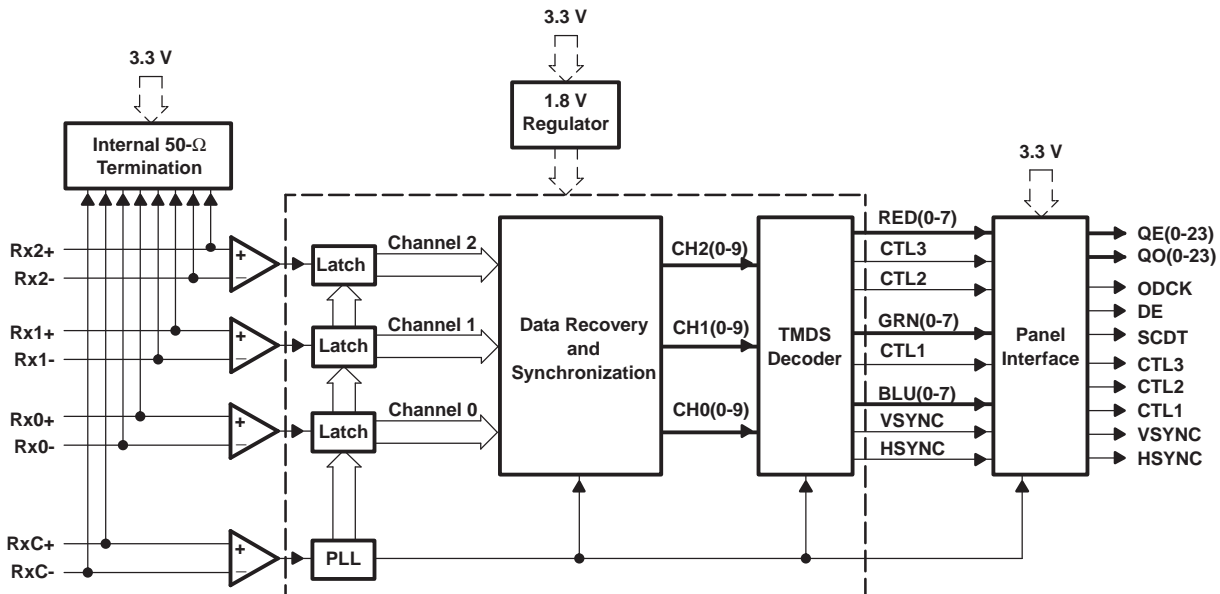

TERMINAL FUNCTIONS

TERMINAL		I/O	DESCRIPTION
NAME	NO.		
AGND	79, 83, 87, 89, 92	GND	Analog ground – Ground reference and current return for analog circuitry
AV <sub>DD</sub>	82, 84, 88, 95	V <sub>DD</sub>	Analog V <sub>DD</sub> – Power supply for analog circuitry. Nominally 3.3 V
CTL[3:1]	42, 41, 40	DO	General-purpose control signals – Used for user-defined control. CTL1 is not powered down via PDO.
DE	46	DO	Output data enable – Used to indicate time of active video display versus non-active display or blank time. During blank, only HSYNC, VSYNC, and CTL[3:1] are transmitted. During times of active display, or non-blank, only pixel data, QE[23:0], and QO[23:0] are transmitted. High: Active display time Low: Blank time
DFO	1	DI	Output clock data format – Controls the output clock (ODCK) format for either TFT or DSTN panel support. For TFT support, the ODCK clock runs continuously. For DSTN support, ODCK only clocks when DE is high; otherwise, ODCK is held low when DE is low. High: DSTN support/ODCK held low when DE = low Low: TFT support/ODCK runs continuously.
DGND	5, 39, 68	GND	Digital ground – Ground reference and current return for digital core
DV <sub>DD</sub>	6, 38, 67	V <sub>DD</sub>	Digital V <sub>DD</sub> – Power supply for digital core. Nominally 3.3 V
EXT_RES	96	AI	Internal impedance matching – The TFP401/401A is internally optimized for impedance matching at 50 Ω. An external resistor tied to this pin has no effect on device performance.
HSYNC	48	DO	Horizontal sync output
RSVD	99	DI	Reserved. Must be tied high for normal operation
OV <sub>DD</sub>	18, 29, 43, 57, 78	V <sub>DD</sub>	Output driver V <sub>DD</sub> – Power supply for output drivers. Nominally 3.3 V
ODCK	44	DO	Output data clock – Pixel clock. All pixel outputs QE[23:0] and QO[23:0] (if in 2-pixel/clock mode), along with DE, HSYNC, VSYNC and CTL[3:1], are synchronized to this clock.
OGND	19, 28, 45, 58, 76	GND	Output driver ground – Ground reference and current return for digital output drivers
OCK_INV	100	DI	ODCK polarity – Selects ODCK edge on which pixel data (QE[23:0] and QO[23:0]) and control signals (HSYNC, VSYNC, DE, CTL[3:1]) are latched. Normal mode: High: Latches output data on rising ODCK edge Low: Latches output data on falling ODCK edge

**TERMINAL FUNCTIONS (continued)**

TERMINAL		I/O	DESCRIPTION
NAME	NO.		
$\overline{\text{PD}}$	2	DI	Power down – An active-low signal that controls the TFP401/401A power-down state. During power down, all output buffers are switched to a high-impedance state. All analog circuits are powered down and all inputs are disabled, except for $\overline{\text{PD}}$ . If $\overline{\text{PD}}$ is left unconnected, an internal pullup defaults the TFP401/401A to normal operation. High : Normal operation Low: Power down
$\overline{\text{PDO}}$	9	DI	Output drive power down – An active-low signal that controls the power-down state of the output drivers. During output drive power down, the output drivers (except SCDT and CTL1) are driven to a high-impedance state. When $\overline{\text{PDO}}$ is left unconnected, an internal pullup defaults the TFP401/401A to normal operation. High: Normal operation/output drivers on Low: Output drive power down
PGND	98	GND	PLL GND – Ground reference and current return for internal PLL
PIXS	4	DI	Pixel select – Selects between one- and two-pixels-per-clock output modes. During the 2-pixel/clock mode, both even pixels, QE[23:0], and odd pixels, QO[23:0], are output in tandem on a given clock cycle. During 1-pixel/clock, even and odd pixels are output sequentially, one at a time, with the even pixel first, on the even pixel bus, QE[23:0]. (The first pixel per line is pixel-0, the even pixel. The second pixel per line is pixel-1, the odd pixel). High: 2-pixel/clock Low: 1-pixel/clock
PV <sub>DD</sub>	97	V <sub>DD</sub>	PLL V <sub>DD</sub> – Power supply for internal PLL
QE[8:15]	20–27	DO	Even green-pixel output – Output for even and odd green pixels when in 1-pixel/clock mode. Output for even-only green pixel when in 2-pixel/clock mode. Output data is synchronized to the output data clock, ODCK. LSB: QE8/pin 20 MSB: QE15/pin 27
QE[16:23]	30–37	DO	Even red-pixel output – Output for even and odd red pixels when in 1-pixel/clock mode. Output for even-only red pixel when in 2-pixel/clock mode. Output data is synchronized to the output data clock, ODCK. LSB: QE16/pin 30 MSB: QE23/pin 37
QO[0:7]	49–56	DO	Odd blue-pixel output – Output for odd-only blue pixel when in 2-pixel/clock mode. Not used, and held low, when in 1-pixel/clock mode. Output data is synchronized to the output data clock, ODCK. LSB: QO0/pin 49 MSB: QO7/pin 56
QO[8:15]	59–66	DO	Odd green-pixel output – Output for odd-only green pixel when in 2-pixel/clock mode. Not used, and held low, when in 1-pixel/clock mode. Output data is synchronized to the output data clock, ODCK. LSB: QO8/pin 59 MSB: QO15/pin 66
QO[16:23]	69–75, 77	DO	Odd red-pixel output – Output for odd-only red pixel when in 2-pixel/clock mode. Not used, and held low, when in 1-pixel/clock mode. Output data is synchronized to the output data clock, ODCK. LSB: QO16/pin 69 MSB: QO23/pin 77
QE[0:7]	10–17	DO	Even blue-pixel output – Output for even and odd blue pixels when in 1-pixel/clock mode. Output for even-only blue pixel when in 2-pixel per clock mode. Output data is synchronized to the output data clock, ODCK. LSB: QE0/pin 10 MSB: QE7/pin 17
RxC+	93	AI	Clock positive receiver input – Positive side of reference clock. TMDS low-voltage signal differential input pair
RxC–	94	AI	Clock negative receiver input – Negative side of reference clock. TMDS low-voltage signal differential input pair
Rx0+	90	AI	Channel-0 positive receiver input – Positive side of channel-0. TMDS low-voltage signal differential input pair. Channel-0 receives blue pixel data in active display and HSYNC, VSYNC control signals in blank.

**TERMINAL FUNCTIONS (continued)**

TERMINAL		I/O	DESCRIPTION
NAME	NO.		
Rx0-	91	AI	Channel-0 negative receiver input – Negative side of channel-0. TMDS low-voltage signal differential input pair
Rx1+	85	AI	Channel-1 positive receiver input – Positive side of channel-1 TMDS low-voltage signal differential input pair Channel-1 receives green-pixel data in active display and CTL1 control signals in blank.
Rx1-	86	AI	Channel-1 negative receiver input – Negative side of channel-1 TMDS low-voltage signal differential input pair
Rx2+	80	AI	Channel-2 positive receiver input – Positive side of channel-2 TMDS low-voltage signal differential input pair Channel-2 receives red-pixel data in active display and CTL2, CTL3 control signals in blank.
Rx2-	81	AI	Channel-2 negative receiver input – Negative side of channel-2 TMDS low-voltage signal differential input pair
SCDT	8	DO	Sync detect - Output to signal when the link is active or inactive. The link is considered to be active when DE is actively switching. The TFP401/401A monitors the state of DE to determine link activity. SCDT can be tied externally to $\overline{P\overline{D}O}$ to power down the output drivers when the link is inactive. High: Active link Low: Inactive link
ST	3	DI	Output drive strength select – Selects output drive strength for high- or low-current drive. (See dc specifications for $I_{OH}$ and $I_{OL}$ vs ST state). High: High drive strength Low: Low drive strength
$\overline{STAG}$	7	DI	Staggered pixel select – An active-low signal used in the 2-pixel/clock pixel mode (PIXS = high). Time-staggeres the even and odd pixel outputs to reduce ground bounce. Normal operation outputs the odd and even pixels simultaneously. High: Normal simultaneous even/odd pixel output Low: Time-staggered even/odd pixel output
VSYNC	47	DO	Vertical sync output

**ABSOLUTE MAXIMUM RATINGS<sup>(1)</sup>**

over operating free-air temperature range (unless otherwise noted)

		MIN	MAX	UNIT
$DV_{DD}$ , $AV_{DD}$ , $OV_{DD}$ , $PV_{DD}$	Supply voltage range	-0.3	4	V
$V_I$	Input voltage range, logic/analog signals	-0.3	4	V
	Operating ambient temperature range	0	70	°C
$T_{stg}$	Storage temperature range	-65	150	°C
	Package power dissipation/PowerPAD package	Soldered <sup>(2)</sup>		W
		Not soldered <sup>(3)</sup>		
	ESD protection, all pins	Human-body model		kV
	JEDEC latchup (EIA/JESD78)	100		mA

- (1) Stresses beyond those listed under *Absolute Maximum Ratings* may cause permanent damage to the device. These are stress ratings only, and functional operation of the device at these or any other conditions beyond those indicated under *Recommended Operating Conditions* is not implied. Exposure to absolute-maximum-rated conditions for extended periods may affect device reliability.
- (2) Specified with PowerPAD bond pad on the backside of the package soldered to a 2-oz. (0.071-mm thick) Cu plate PCB thermal plane. Specified at maximum allowed operating temperature, 70°C.
- (3) PowerPAD bond pad on the backside of the package is not soldered to a thermal plane. Specified at maximum allowed operating temperature, 70°C.

**THERMAL INFORMATION**

THERMAL METRIC <sup>(1)</sup>		TFP401, TFP401A	UNIT
		PZP	
		100 PINS	
$\theta_{JA}$	Junction-to-ambient thermal resistance	26	°C/W
$\theta_{JCTop}$	Junction-to-case (top) thermal resistance	12.3	°C/W
$\theta_{JB}$	Junction-to-board thermal resistance	7.3	°C/W
$\psi_{JT}$	Junction-to-top characterization parameter	0.3	°C/W
$\psi_{JB}$	Junction-to-board characterization parameter	7.2	°C/W
$\theta_{JCbott}$	Junction-to-case (bottom) thermal resistance	1.6	°C/W

(1) For more information about traditional and new thermal metrics, see the *IC Package Thermal Metrics* application report, [SPRA953](#).

**RECOMMENDED OPERATING CONDITIONS**

		MIN	NOM	MAX	UNIT
$V_{DD}$ ( $DV_{DD}$ , $AV_{DD}$ , $PV_{DD}$ , $OV_{DD}$ )	Supply voltage	3	3.3	3.6	V
$t_{pix}$ <sup>(1)</sup>	Pixel time	6.06		40	ns
$R_t$	Single-ended analog-input termination resistance	45	50	55	$\Omega$
$T_A$	Operating free-air temperature	0	25	70	°C

(1)  $t_{pix}$  is the pixel time defined as the period of the Rx/C clock input. The period of the output clock, ODCK is equal to  $t_{pix}$  when in 1-pixel/clock mode and  $2t_{pix}$  when in 2-pixel/clock mode.

**DC DIGITAL I/O ELECTRICAL CHARACTERISTICS**

over operating free-air temperature range (unless otherwise noted)

PARAMETER		TEST CONDITIONS	MIN	TYP	MAX	UNIT
$V_{IH}$	High-level digital input voltage <sup>(1)</sup>		2		$DV_{DD}$	V
$V_{IL}$	Low-level digital input voltage <sup>(1)</sup>		0		0.8	V
$I_{OH}$	High-level output drive current <sup>(2)</sup>	ST = high, $V_{OH} = 2.4$ V	5	10	14	mA
		ST = low, $V_{OH} = 2.4$ V	3	6	9	
$I_{OL}$	Low-level output drive current <sup>(2)</sup>	ST = high, $V_{OL} = 0.8$ V	10	13	19	mA
		ST = low, $V_{OL} = 0.8$ V	5	7	11	
$I_{OZ}$	Hi-Z output leakage current	$\overline{PD} = \text{low}$ or $\overline{P\overline{D}O} = \text{low}$	-1		1	$\mu$ A

(1) Digital inputs are labeled DI in I/O column of Terminal Functions table.

(2) Digital outputs are labeled DO in I/O column of Terminal Functions table.

## DC ELECTRICAL CHARACTERISTICS

over operating free-air temperature range (unless otherwise noted)

PARAMETER		TEST CONDITIONS	MIN	TYP	MAX	UNIT
V <sub>ID</sub>	Analog input differential voltage <sup>(1)</sup>		75		1200	mV
V <sub>IC</sub>	Analog input common-mode voltage <sup>(1)</sup>		AV <sub>DD</sub> – 300		AV <sub>DD</sub> – 37	mV
V <sub>I(OC)</sub>	Open-circuit analog input voltage		AV <sub>DD</sub> – 10		AV <sub>DD</sub> + 10	mV
I <sub>DD(2PIX)</sub>	Normal 2-pix/clock power supply current <sup>(2)</sup>	ODCK = 82.5 MHz, 2-pix/clock			370	mA
I <sub>PD</sub>	Power-down current <sup>(3)</sup>	$\overline{PD}$ = low			10	mA
I <sub>PDO</sub>	Output drive power-down current <sup>(3)</sup>	$\overline{PDO}$ = low		35		mA

(1) Specified as dc characteristic with no overshoot or undershoot

(2) Alternating 2-pixel black/2-pixel white pattern. ST = high, STAG = high, QE[23:0] and QO[23:0] C<sub>L</sub> = 10 pF.

(3) Analog inputs are open circuit (transmitter is disconnected from TFP401/401A).

## AC ELECTRICAL CHARACTERISTICS

over recommended operating free-air temperature range (unless otherwise noted)

PARAMETER		TEST CONDITIONS	MIN	TYP	MAX	UNIT
V <sub>ID(2)</sub>	Differential input sensitivity <sup>(1)</sup>		150		1560	mV <sub>p-p</sub>
t <sub>ps</sub>	Analog input intra-pair (+ to –) differential skew <sup>(2)</sup>				0.4	t <sub>bit</sub> <sup>(3)</sup>
t <sub>ocs</sub>	Analog input inter-pair or channel-to-channel skew <sup>(2)</sup>				1	t <sub>pix</sub> <sup>(4)</sup>
t <sub>jit</sub>	Worst-case differential input clock jitter tolerance <sup>(2)(5)</sup>		50			ps
t <sub>f1</sub>	Fall time of data and control signals <sup>(6)(7)</sup>	ST = low, C <sub>L</sub> = 5 pF			2.4	ns
		ST = high, C <sub>L</sub> = 10 pF			1.9	
t <sub>r1</sub>	Rise time of data and control signals <sup>(6)(7)</sup>	ST = low, C <sub>L</sub> = 5 pF			2.4	ns
		ST = high, C <sub>L</sub> = 10 pF			1.9	
t <sub>r2</sub>	Rise time of ODCK clock <sup>(6)</sup>	ST = low, C <sub>L</sub> = 5 pF			2.4	ns
		ST = high, C <sub>L</sub> = 10 pF			1.9	
t <sub>f2</sub>	Fall time of ODCK clock <sup>(6)</sup>	ST = low, C <sub>L</sub> = 5 pF			2.4	ns
		ST = high, C <sub>L</sub> = 10 pF			1.9	
t <sub>su1</sub>	Setup time, data and control signal to falling edge of ODCK	1 pixel/clock, PIXS = low, OCK_INV = low	1.8			ns
		2 pixel/clock, PIXS = high, STAG = high, OCK_INV = low	3.8			
		2 pixel and STAG, PIXS = high, STAG = low, OCK_INV = low	0.7			
t <sub>h1</sub>	Hold time, data and control signal to falling edge of ODCK	1 pixel/clock, PIXS = low, OCK_INV = low	0.6			ns
		2 pixel and STAG, PIXS = high, STAG = low, OCK_INV = low	2.5			
		2 pixel/clock, PIXS = high, STAG = high, OCK_INV = low	2.9			

(1) Specified as ac parameter to include sensitivity to overshoot, undershoot and reflection.

(2) By characterization

(3) t<sub>bit</sub> is 1/10 the pixel time, t<sub>pix</sub>

(4) t<sub>pix</sub> is the pixel time defined as the period of the Rx/C input clock. The period of ODCK is equal to t<sub>pix</sub> in 1-pixel/clock mode or 2t<sub>pix</sub> when in 2-pixel/clock mode.

(5) Measured differentially at 50% crossing using ODCK output clock as trigger

(6) Rise and fall times measured as time between 20% and 80% of signal amplitude.

(7) Data and control signals are QE[23:0], QO[23:0], DE, HSYNC, VSYNC. and CTL[3:1].

### AC ELECTRICAL CHARACTERISTICS (continued)

over recommended operating free-air temperature range (unless otherwise noted)

PARAMETER		TEST CONDITIONS	MIN	TYP	MAX	UNIT
$t_{su2}$	Setup time, data and control signal to rising edge of ODCK	1 pixel/clock, PIXS = low, OCK_INV = high	2.1			ns
		2 pixel/clock, PIXS = high, STAG = high, OCK_INV = high	4			
		2 pixel and STAG, PIXS = high, STAG = low, OCK_INV = high	1.5			
$t_{h2}$	Hold time, data and control signal to rising edge of ODCK	1 pixel/clock, PIXS = low, OCK_INV = high	0.5			ns
		2 pixel and STAG, PIXS = high, STAG = low, OCK_INV = high	2.4			
		2 pixel/clock, PIXS = high, STAG = high, OCK_INV = high	2.1			
$f_{ODCK}$	ODCK frequency	PIX = low (1-PIX/CLK)	25		165	MHz
		PIX = high (2-PIX/CLK)	12.5		82.5	
	ODCK duty-cycle		45%	60%	75%	
$t_{pd(PDL)}$	Propagation delay time from $\overline{PD}$ low to Hi-Z outputs				9	ns
$t_{pd(PDOL)}$	Propagation delay time from $\overline{PDO}$ low to Hi-Z outputs				9	ns
$t_t(HSC)$	Transition time between DE transition to SCDT low <sup>(8)</sup>			1e6		$t_{pix}$
$t_t(FSC)$	Transition time between DE transition to SCDT high <sup>(8)</sup>			1600		$t_{pix}$
$t_{d(st)}$	Delay time, ODCK latching edge to QE[23:0] data output	$\overline{STAG}$ = low, PIXS = high		0.25		$t_{pix}$

(8) Link active or inactive is determined by amount of time detected between DE transitions. SCDT indicates link activity.



PARAMETER MEASUREMENT INFORMATION

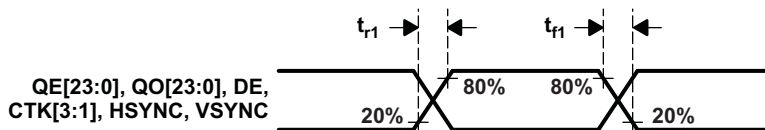

Figure 1. Rise and Fall Times of Data and Control Signals

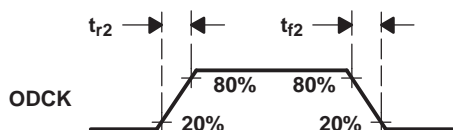

Figure 2. Rise and Fall Times of ODCK

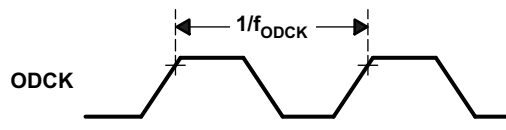

Figure 3. ODCK Frequency

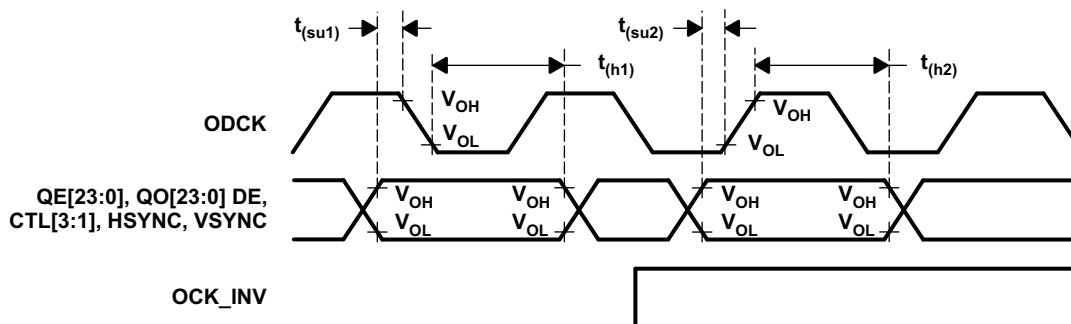

Figure 4. Data Setup and Hold Times to Rising and Falling Edges of ODCK

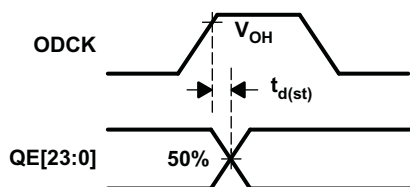

Figure 5. ODCK High to QE[23:0] Staggered Data Output

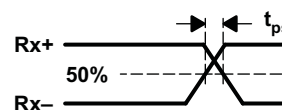

Figure 6. Analog Input Intra-Pair Differential Skew

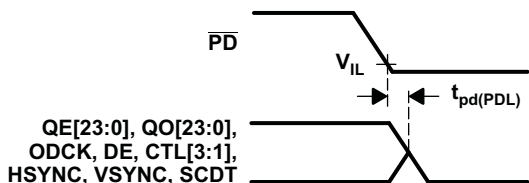

Figure 7. Delay From  $\overline{PD}$  Low to Hi-Z Outputs

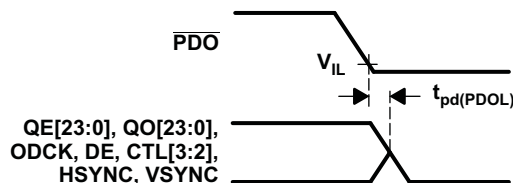

Figure 8. Delay From  $\overline{PDO}$  Low to Hi-Z Outputs

PARAMETER MEASUREMENT INFORMATION (continued)

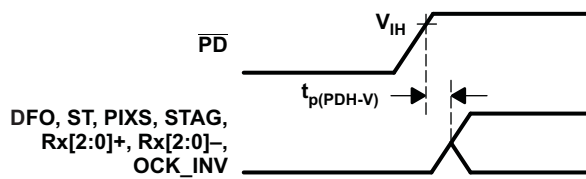

Figure 9. Delay From  $\overline{\text{PD}}$  Low to High Before Inputs Are Active

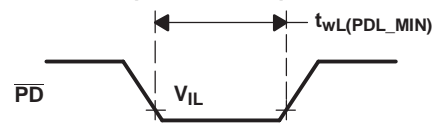

Figure 10. Minimum Time  $\overline{\text{PD}}$  Low

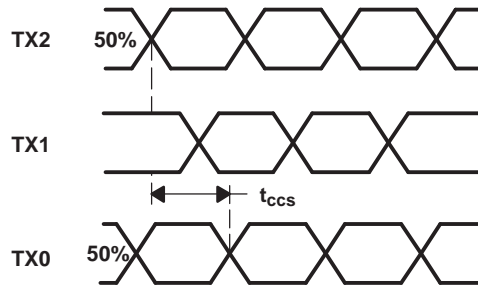

Figure 11. Analog Input Channel-to-Channel Skew

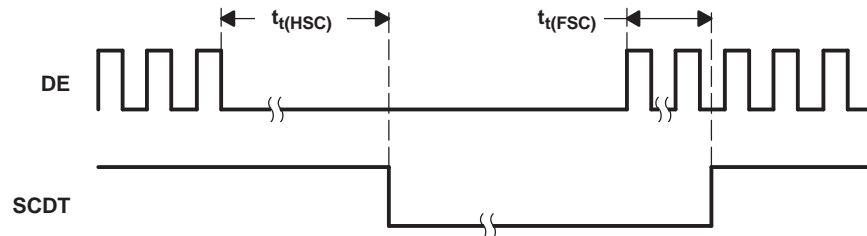

Figure 12. Time Between DE Transitions to SCDT Low and SCDT High

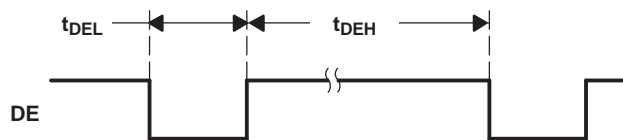

Figure 13. Minimum DE Low and Maximum DE High

DETAILED DESCRIPTION

FUNDAMENTAL OPERATION

The TFP401/401A is a digital visual interface (DVI)-compliant TMDS digital receiver that is used in digital flat panel display systems to receive and decode TMDS-encoded RGB pixel data streams. In a digital display system a host, usually a PC or workstation, contains a TMDS-compatible transmitter that receives 24-bit pixel data along with appropriate control signals and encodes them into a high-speed low-voltage differential serial bit stream fit for transmission over a twisted-pair cable to a display device. The display device, usually a flat-panel monitor,

requires a TMDS-compatible receiver like the TI TFP401/401A to decode the serial bit stream back to the same 24-bit pixel data and control signals that originated at the host. This decoded data can then be applied directly to the flat-panel drive circuitry to produce an image on the display. Because the host and display can be separated by distances up to 5 meters or more, serial transmission of the pixel data is preferred. To support modern display resolutions up to UXGA, a high-bandwidth receiver with good jitter and skew tolerance is required.

## TMDS PIXEL DATA AND CONTROL SIGNAL ENCODING

TMDS stands for transition-minimized differential signaling. Only one of two possible TMDS characters for a given pixel is transmitted at a given time. The transmitter keeps a running count of the number of ones and zeros previously sent, and transmits the character that minimizes the number of transitions to approximate a dc balance of the transmission line.

Three TMDS channels are used to receive RGB pixel data during active display time, DE = high. The same three channels also receive control signals, HSYNC, VSYNC, and user-defined control signals CTL[3:1]. These control signals are received during inactive display or blanking-time. Blanking-time is when DE = low. The following table maps the received input data to the appropriate TMDS input channel in a DVI-compliant system.

RECEIVED PIXEL DATA ACTIVE DISPLAY DE = HIGH	INPUT CHANNEL	OUTPUT PINS (VALID FOR DE = HIGH)
Red[7:0]	Channel-2 (Rx2 ±)	QE[23:16] QO[23:16]
Green[7:0]	Channel-1 (Rx1 ±)	QE[15:8] QO[15:8]
Blue[7:0]	Channel-0 (Rx0 ±)	QE[7:0] QO[7:0]
RECEIVED CONTROL DATA BLANKING DE = LOW	INPUT CHANNEL	OUTPUT PINS (VALID FOR DE = LOW)
CTL[3:2]	Channel-2 (Rx2 ±)	CTL[3:2]
CTL[1: 0] <sup>(1)</sup>	Channel-1 (Rx1 ±)	CTL1
HSYNC, VSYNC	Channel-0 (Rx0 ±)	HSYNC, VSYNC

(1) Some TMDS transmitters transmit a CTL0 signal. The TFP401/401A decodes and transfers CTL[3:1] and ignores CTL0 characters. CTL0 is not available as a TFP401/401A output.

The TFP401/401A discriminates between valid pixel TMDS characters and control TMDS characters to determine the state of active display versus blanking, i.e., the state of DE.

## TFP401/401A CLOCKING AND DATA SYNCHRONIZATION

The TFP401/401A receives a clock reference from the DVI transmitter that has a period equal to the pixel time,  $t_{pix}$ . The frequency of this clock is also referred to as the pixel rate. Because the TMDS encoded data on Rx[2:0] contains 10 bits per 8-bit pixel, it follows that the Rx[2:0] serial bit rate is 10 times the pixel rate. For example, the required pixel rate to support a UXGA resolution with 60-Hz refresh rate is 165 MHz. The TMDS serial bit rate is 10× the pixel rate, or 1.65 Gb/s. Due to the transmission of this high-speed digital bit stream, on three separate channels (or twisted-pair wires) of long distances (3–5 meters), phase synchronization between the data streams and the input reference clock is not assured. In addition, skew between the three data channels is common. The TFP401/401A uses a 4× oversampling scheme of the input data streams to achieve reliable synchronization with up to  $1-t_{pix}$  channel-to-channel skew tolerance. Accumulated jitter on the clock and data lines due to reflections and external noise sources is also typical of high-speed serial data transmission; hence, the TFP401/401A design for high jitter tolerance.

The input clock to the TFP401/401A is conditioned by a phase-locked loop (PLL) to remove high-frequency jitter from the clock. The PLL provides four 10× clock outputs of different phase to locate and sync the TMDS data streams (4× oversampling). During active display, the pixel data is encoded to be transition-minimized, whereas in blank, the control data is encoded to be transition-maximized. A DVI-compliant transmitter is required to transmit in blank for a minimum period of time,  $128 t_{pix}$ , to ensure sufficient time for data synchronization when the receiver sees a transition-maximized code. Synchronization during blank, when the data is transition-maximized, ensures reliable data-bit boundary detection. Phase synchronization to the data streams is unique for each of the three input channels and is maintained as long as the link remains active.

## TFP401/401A TMDS INPUT LEVELS AND INPUT IMPEDANCE MATCHING

The TMDS inputs to the TFP401/401A receiver have a fixed single-ended termination to  $AV_{DD}$ . The TFP401/401A is internally optimized using a laser trim process to precisely fix the impedance at  $50\ \Omega$ . The device functions normally with or without a resistor on the EXT\_RES pin, so it remains drop-in compatible with current sockets. The fixed impedance eliminates the need for an external resistor while providing optimum impedance matching to standard  $50\text{-}\Omega$  DVI cables.

Figure 14 shows a conceptual schematic of a DVI transmitter and TFP401/401A receiver connection. A transmitter drives the twisted-pair cable via a current source, usually achieved with an open-drain type output driver. The internal resistor, which is matched to the cable impedance at the TFP401/401A input, provides a pullup to  $AV_{DD}$ . Naturally, when the transmitter is disconnected and the TFP401/401A DVI inputs are left unconnected, the TFP401/401A receiver inputs pull up to  $AV_{DD}$ . The single-ended differential signal and full-differential signal is shown in Figure 15. The TFP401/401A is designed to respond to differential signal swings ranging from  $150\text{ mV}$  to  $1.56\text{ V}$  with common-mode voltages ranging from  $(AV_{DD} - 300\text{ mV})$  to  $(AV_{DD} - 37\text{ mV})$ .

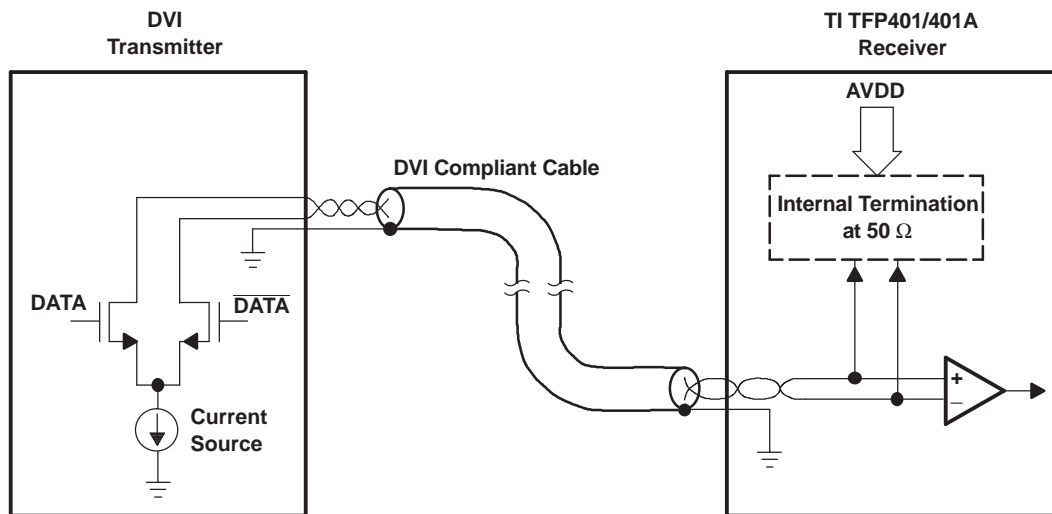

Figure 14. TMDS Differential Input and Transmitter Connection

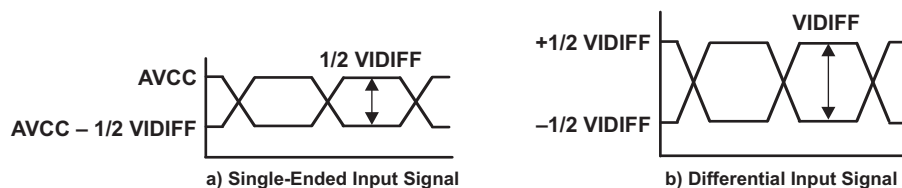

Figure 15. TMDS Inputs

## TFP401A INCORPORATES HSYNC JITTER IMMUNITY

Several DVI transmitters available in the market introduce jitter on the transmitted HSYNC and VSYNC signals during the TMDS encryption process. The HSYNC signal can shift by one pixel position (one clock) from nominal in either direction, resulting in up to two cycles of HSYNC shift. This jitter carries through to the DVI receiver, and if the position of HSYNC shifts continuously, the receiver can lose track of the input timing, causing pixel noise to occur on the display. For this reason, a DVI-compliant receiver with HSYNC jitter immunity should be used in all displays that could be connected to host PCs with transmitters that have this HSYNC jitter problem.

The TFP401A integrates HSYNC regeneration circuitry that provides a seamless interface to these noncompliant transmitters. The position of the data enable (DE) signal is always fixed in relation to data, irrespective of the location of HSYNC. The TFP401A receiver uses the DE and clock signals to recreate stable vertical and horizontal sync signals. The circuit filters the HSYNC output of the receiver, and HSYNC is shifted to the nearest eighth bit boundary, producing a stable output with respect to data, as shown in Figure 16. This ensures accurate data synchronization at the input of the display timing controller.

This HSYNC regeneration circuit is transparent to the monitor and need not be removed even if the transmitted HSYNC is stable. For example, the PanelBus line of DVI 1.0 compliant transmitters, such as the TFP6422 and TFP420, do not have the HSYNC jitter problem. The TFP401A operates correctly with either compliant or noncompliant transmitters. In contrast, the TFP401 is ideal for customers who have control over the transmit portion of the design, such as bundled system manufacturers and for internal monitor use (the DVI connection between monitor and panel modules).

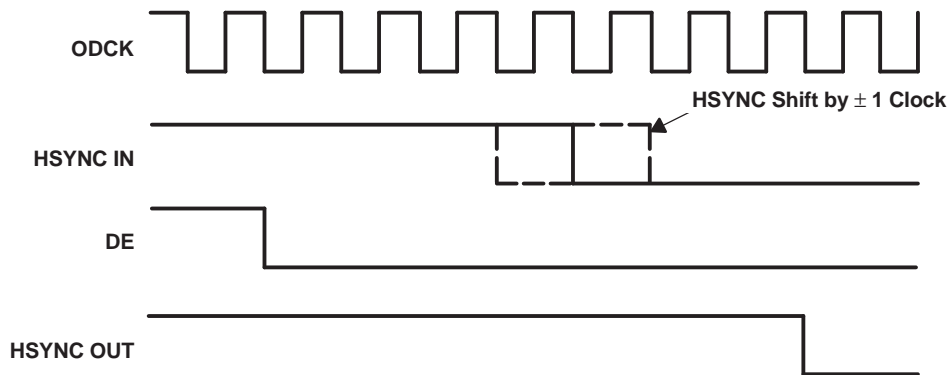

Figure 16. HSYNC Regeneration Timing Diagram

## TFP401/401A MODES OF OPERATION

The TFP401/401A provides system design flexibility and value by providing the system designer with configurable options or modes of operation to support varying system architectures. The following table outlines the various panel modes that can be supported, along with appropriate external control pin settings.

PANEL	PIXEL RATE	ODCK LATCH EDGE	ODCK	DFO	PIXS	OCK_INV
TFT or 16-bit DSTN	1 pix/clock	Falling	Free run	0	0	0
TFT or 16-bit DSTN	1 pix/clock	Rising	Free run	0	0	1
TFT	2 pix/clock	Falling	Free run	0	1	0
TFT	2 pix/clock	Rising	Free run	0	1	1
24-bit DSTN	1 pix/clock	Falling	Gated low	1	0	0
NONE	1 pix/clock	Rising	Gated low	1	0	1
24-bit DSTN	2 pix/clock	Falling	Gated low	1	1	0
24-bit DSTN	2 pix/clock	Rising	Gated low	1	1	1

## TFP401/401A OUTPUT DRIVER CONFIGURATIONS

The TFP401/401A provides flexibility by offering various output driver features that can be used to optimize power consumption, ground bounce, and power-supply noise. The following sections outline the output driver features and their effects.

**Output Driver Power Down ( $\overline{PDO}$  = low).** Pulling  $\overline{PDO}$  low places all the output drivers, except CTL1 and SCDDT, into a high-impedance state. The SCDDT output, which indicates link-disabled or link-inactive, can be tied directly to the  $\overline{PDO}$  input to disable the output drivers when the link is inactive or when the cable is disconnected. An internal pullup on the  $\overline{PDO}$  pin defaults the TFP401/401A to the normal nonpower-down output drive mode if left unconnected.

**Drive Strength** (ST = high for high drive strength, ST = low for low drive strength). The TFP401/401A allows for selectable output drive strength on the data, control, and ODCK outputs. See the *DC Electrical Characteristics* table for the values of  $I_{OH}$  and  $I_{OL}$  current drives for a given ST state. The high output drive strength offers approximately two times the drive as the low-output drive strength.

**Time-Staggered Pixel Output.** This option works only in conjunction with the 2-pixel/clock mode (PIXS = high). Setting  $\overline{STAG}$  = low time-staggeres the even- and odd-pixel outputs so as to reduce the amount of instantaneous current surge from the power supply. Depending on the PCB layout and design, this can help reduce the amount of system ground bounce and power-supply noise. The time stagger is such that in 2-pixel/clock mode, the even pixel is delayed from the latching edge of ODCK by  $0.25 t_{cip}$ . ( $t_{cip}$  is the period of ODCK. The ODCK period is  $2 t_{pix}$  when in 2-pixel/clock mode.)

Depending on system constraints of output load, pixel rate, panel input architecture, and board cost, the TFP401/401A drive-strength and staggered-pixel options allow flexibility to reduce system power-supply noise, ground bounce, and EMI.

**Power Management.** The TFP401/401A offers several system power-management features.

The output driver power down ( $\overline{PDO}$  = low) is an intermediate mode which offers several uses. During this mode, all output drivers except SCDT and CTL1 are driven to a high-impedance state while the rest of the device circuitry remains active.

The TFP401/401A power down ( $\overline{PD}$  = low) is a complete power down in that it powers down the digital core, the analog circuitry, and output drivers. All output drivers are placed into a Hi-Z state. All inputs are disabled except for the  $\overline{PD}$  input. The TFP401/401A does not respond to any digital or analog inputs until  $\overline{PD}$  is pulled high.

Both  $\overline{PDO}$  and  $\overline{PD}$  have internal pullups, so if left unconnected they default the TFP401/401A to normal operating modes.

**Sync Detect.** The TFP401/401A offers an output, SCDT, to indicate link activity. The TFP401/401A monitors activity on DE to determine if the link is active. When 1 million (1e6) pixel clock periods pass without a transition on DE, the TFP401/401A considers the link inactive, and SCDT is driven low. While SCDT is low, if two DE transitions are detected within 1600 pixel clock periods, the link is considered active, and SCDT is pulled high.

SCDT can be used to signal a system power management circuit to initiate a system power down when the link is considered inactive. The SCDT can also be tied directly to the TFP401/401A  $\overline{PDO}$  input to power down the output drivers when the link is inactive. It is not recommended to use SCDT to drive the  $\overline{PD}$  input, because once in complete power-down, the analog inputs are ignored and the SCDT state does not change. An external system power-management circuit to drive  $\overline{PD}$  is preferred.

## TI PowerPAD 100-TQFP PACKAGE

The TFP401/401A is packaged in TI's thermally enhanced PowerPAD 100-TQFP packaging. The PowerPAD package is a 14-mm × 14-mm × 1-mm TQFP outline with 0.5-mm lead pitch. The PowerPAD package has a specially designed die mount pad that offers improved thermal capability over typical TQFP packages of the same outline. The TI 100-TQFP PowerPAD package offers a back-side solder plane that connects directly to the die mount pad for enhanced thermal conduction. Soldering the back side of the TFP401/401A to the application board is not required thermally, because the device power dissipation is well within the package capability when not soldered.

Soldering the back side of the device to the PCB ground plane is recommended for electrical considerations. Because the die pad is electrically connected to the chip substrate and hence to chip ground, connection of the PowerPAD back side to a PCB ground plane helps to improve EMI, ground bounce, and power-supply noise performance.

**Table 1** outlines the thermal properties of the TI 100-TQFP PowerPAD package. The 100-TQFP non-PowerPAD package is included only for reference.

**Table 1. TI 100-TQFP (14 mm × 14 mm × 1 mm) / 0.5-mm Lead Pitch**

PARAMETER	WITHOUT PowerPAD™ Package	PowerPAD™ Package, NOT CONNECTED TO PCB THERMAL PLANE	PowerPAD™ Package, CONNECTED TO PCB THERMAL PLANE <sup>(1)</sup>
Theta-JA <sup>(1) (2)</sup>	45°C/W	27.3°C/W	17.3°C/W
Theta-JC <sup>(1)(2)</sup>	3.11°C/W	0.12°C/W	0.12°C/W
Maximum power dissipation <sup>(1)(2)(3)</sup>	1.6 W	2.7 W	4.3 W

(1) Specified with 2-oz. (0.071 mm thick) Cu PCB plating

(2) Airflow is at 0 LFM (0 m/s) (no airflow).

(3) Measured at ambient temperature, T<sub>A</sub> = 70°C

**PACKAGING INFORMATION**

Orderable Device	Status <sup>(1)</sup>	Package Type	Package Drawing	Pins	Package Qty	Eco Plan <sup>(2)</sup>	Lead/ Ball Finish	MSL Peak Temp <sup>(3)</sup>	Samples (Requires Login)
TFP401APZP	ACTIVE	HTQFP	PZP	100	90	Green (RoHS & no Sb/Br)	CU NIPDAU	Level-3-260C-168 HR	
TFP401APZPG4	ACTIVE	HTQFP	PZP	100	90	Green (RoHS & no Sb/Br)	CU NIPDAU	Level-3-260C-168 HR	
TFP401PZP	ACTIVE	HTQFP	PZP	100	90	Green (RoHS & no Sb/Br)	CU NIPDAU	Level-3-260C-168 HR	
TFP401PZPG4	ACTIVE	HTQFP	PZP	100	90	Green (RoHS & no Sb/Br)	CU NIPDAU	Level-3-260C-168 HR	

<sup>(1)</sup> The marketing status values are defined as follows:

**ACTIVE:** Product device recommended for new designs.

**LIFEBUY:** TI has announced that the device will be discontinued, and a lifetime-buy period is in effect.

**NRND:** Not recommended for new designs. Device is in production to support existing customers, but TI does not recommend using this part in a new design.

**PREVIEW:** Device has been announced but is not in production. Samples may or may not be available.

**OBSELETE:** TI has discontinued the production of the device.

<sup>(2)</sup> Eco Plan - The planned eco-friendly classification: Pb-Free (RoHS), Pb-Free (RoHS Exempt), or Green (RoHS & no Sb/Br) - please check <http://www.ti.com/productcontent> for the latest availability information and additional product content details.

**TBD:** The Pb-Free/Green conversion plan has not been defined.

**Pb-Free (RoHS):** TI's terms "Lead-Free" or "Pb-Free" mean semiconductor products that are compatible with the current RoHS requirements for all 6 substances, including the requirement that lead not exceed 0.1% by weight in homogeneous materials. Where designed to be soldered at high temperatures, TI Pb-Free products are suitable for use in specified lead-free processes.

**Pb-Free (RoHS Exempt):** This component has a RoHS exemption for either 1) lead-based flip-chip solder bumps used between the die and package, or 2) lead-based die adhesive used between the die and leadframe. The component is otherwise considered Pb-Free (RoHS compatible) as defined above.

**Green (RoHS & no Sb/Br):** TI defines "Green" to mean Pb-Free (RoHS compatible), and free of Bromine (Br) and Antimony (Sb) based flame retardants (Br or Sb do not exceed 0.1% by weight in homogeneous material)

<sup>(3)</sup> MSL, Peak Temp. -- The Moisture Sensitivity Level rating according to the JEDEC industry standard classifications, and peak solder temperature.

**Important Information and Disclaimer:** The information provided on this page represents TI's knowledge and belief as of the date that it is provided. TI bases its knowledge and belief on information provided by third parties, and makes no representation or warranty as to the accuracy of such information. Efforts are underway to better integrate information from third parties. TI has taken and continues to take reasonable steps to provide representative and accurate information but may not have conducted destructive testing or chemical analysis on incoming materials and chemicals. TI and TI suppliers consider certain information to be proprietary, and thus CAS numbers and other limited information may not be available for release.

In no event shall TI's liability arising out of such information exceed the total purchase price of the TI part(s) at issue in this document sold by TI to Customer on an annual basis.

**OTHER QUALIFIED VERSIONS OF TFP401A :**



- Enhanced Product: [TFP401A-EP](#)

NOTE: Qualified Version Definitions:

- Enhanced Product - Supports Defense, Aerospace and Medical Applications

# MECHANICAL DATA

PZP (S-PQFP-G100)

PowerPAD™ PLASTIC QUAD FLATPACK

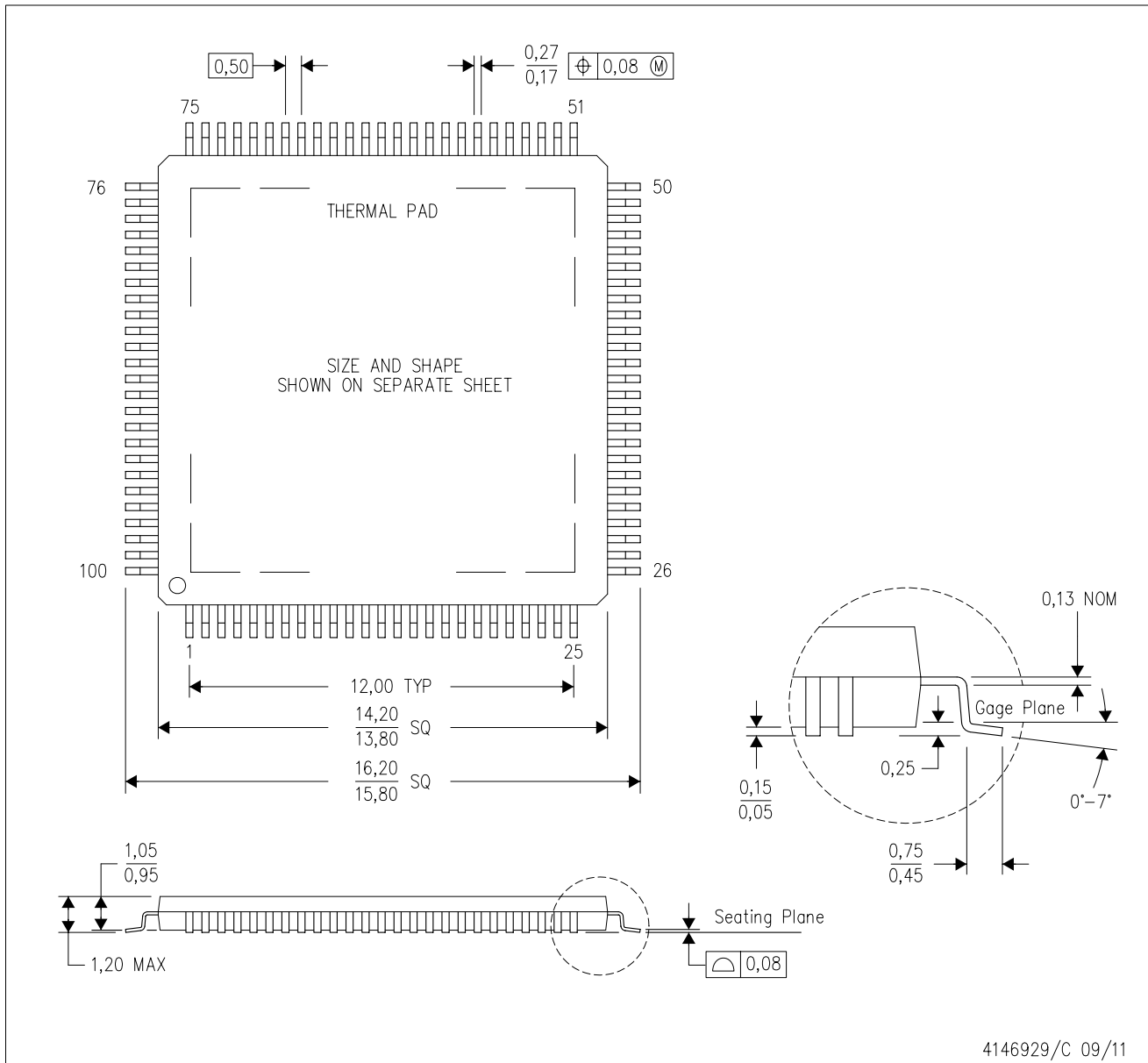

- NOTES:
- All linear dimensions are in millimeters.
  - This drawing is subject to change without notice.
  - Body dimensions do not include mold flash or protrusion
  - This package is designed to be soldered to a thermal pad on the board. Refer to Technical Brief, PowerPad Thermally Enhanced Package, Texas Instruments Literature No. SLMA002 for information regarding recommended board layout. This document is available at [www.ti.com](http://www.ti.com) <<http://www.ti.com>>.
  - See the additional figure in the Product Data Sheet for details regarding the exposed thermal pad features and dimensions.
  - Falls within JEDEC MS-026

PowerPAD is a trademark of Texas Instruments.

# THERMAL PAD MECHANICAL DATA

PZP (S-PQFP-G100)

PowerPAD™ PLASTIC QUAD FLATPACK

## THERMAL INFORMATION

This PowerPAD™ package incorporates an exposed thermal pad that is designed to be attached to a printed circuit board (PCB). The thermal pad must be soldered directly to the PCB. After soldering, the PCB can be used as a heatsink. In addition, through the use of thermal vias, the thermal pad can be attached directly to the appropriate copper plane shown in the electrical schematic for the device, or alternatively, can be attached to a special heatsink structure designed into the PCB. This design optimizes the heat transfer from the integrated circuit (IC).

For additional information on the PowerPAD package and how to take advantage of its heat dissipating abilities, refer to Technical Brief, PowerPAD Thermally Enhanced Package, Texas Instruments Literature No. SLMA002 and Application Brief, PowerPAD Made Easy, Texas Instruments Literature No. SLMA004. Both documents are available at [www.ti.com](http://www.ti.com).

The exposed thermal pad dimensions for this package are shown in the following illustration.

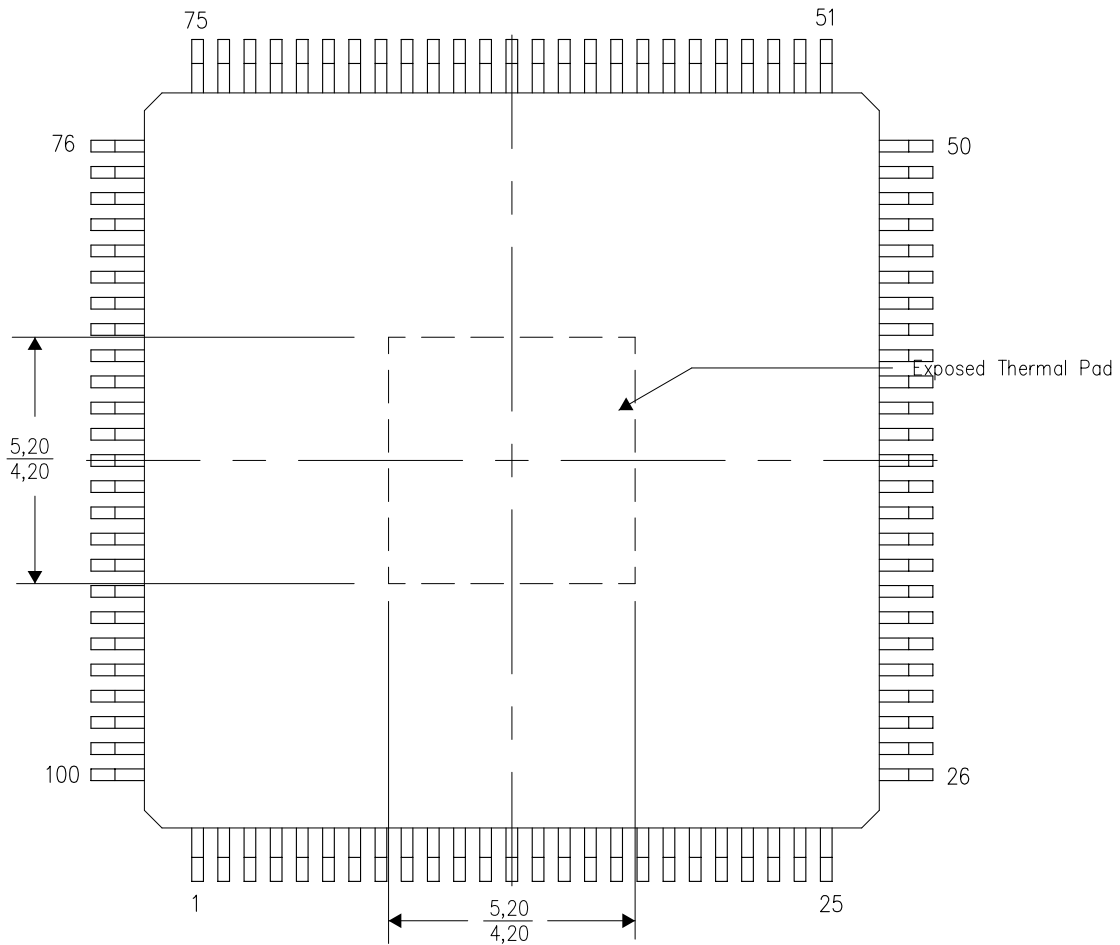

Top View

Exposed Thermal Pad Dimensions

4206333-2/G 09/11

NOTE: A. All linear dimensions are in millimeters

## PZP (S-PQFP-G100) PowerPAD™

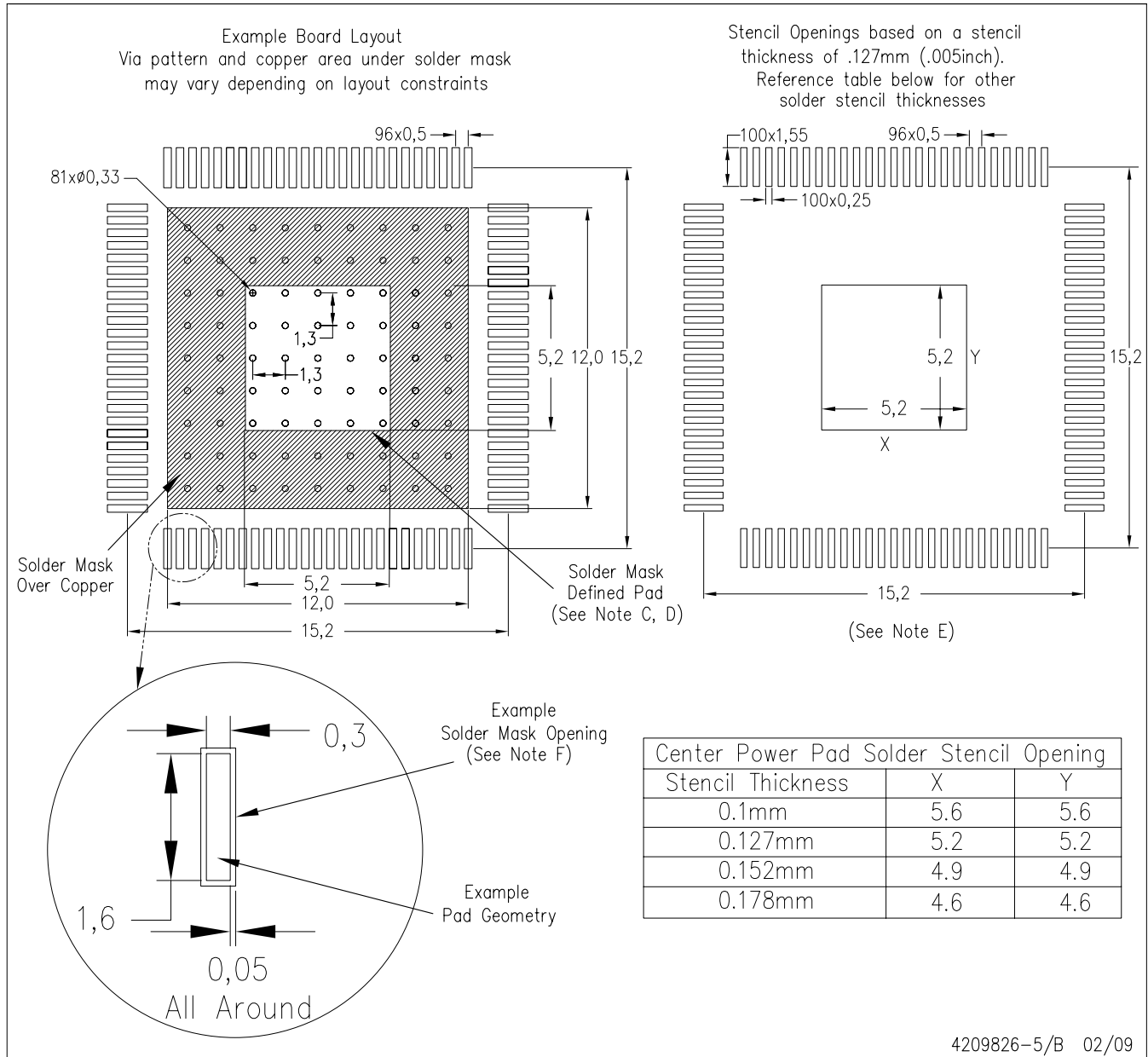

- NOTES:
- All linear dimensions are in millimeters.
  - This drawing is subject to change without notice.
  - Customers should place a note on the circuit board fabrication drawing not to alter the center solder mask defined pad.
  - This package is designed to be soldered to a thermal pad on the board. Refer to Technical Brief, PowerPAD Thermally Enhanced Package, Texas Instruments Literature No. SLMA002, SLMA004, and also the Product Data Sheets for specific thermal information, via requirements, and recommended board layout. These documents are available at [www.ti.com](http://www.ti.com) <<http://www.ti.com>>. Publication IPC-7351 is recommended for alternate designs.
  - Laser cutting apertures with trapezoidal walls and also rounding corners will offer better paste release. Customers should contact their board assembly site for stencil design recommendations. Example stencil design based on a 50% volumetric metal load solder paste. Refer to IPC-7525 for other stencil recommendations.
  - Customers should contact their board fabrication site for solder mask tolerances between and around signal pads.

PowerPAD is a trademark of Texas Instruments.

## IMPORTANT NOTICE

Texas Instruments Incorporated and its subsidiaries (TI) reserve the right to make corrections, modifications, enhancements, improvements, and other changes to its products and services at any time and to discontinue any product or service without notice. Customers should obtain the latest relevant information before placing orders and should verify that such information is current and complete. All products are sold subject to TI's terms and conditions of sale supplied at the time of order acknowledgment.

TI warrants performance of its hardware products to the specifications applicable at the time of sale in accordance with TI's standard warranty. Testing and other quality control techniques are used to the extent TI deems necessary to support this warranty. Except where mandated by government requirements, testing of all parameters of each product is not necessarily performed.

TI assumes no liability for applications assistance or customer product design. Customers are responsible for their products and applications using TI components. To minimize the risks associated with customer products and applications, customers should provide adequate design and operating safeguards.

TI does not warrant or represent that any license, either express or implied, is granted under any TI patent right, copyright, mask work right, or other TI intellectual property right relating to any combination, machine, or process in which TI products or services are used. Information published by TI regarding third-party products or services does not constitute a license from TI to use such products or services or a warranty or endorsement thereof. Use of such information may require a license from a third party under the patents or other intellectual property of the third party, or a license from TI under the patents or other intellectual property of TI.

Reproduction of TI information in TI data books or data sheets is permissible only if reproduction is without alteration and is accompanied by all associated warranties, conditions, limitations, and notices. Reproduction of this information with alteration is an unfair and deceptive business practice. TI is not responsible or liable for such altered documentation. Information of third parties may be subject to additional restrictions.

Resale of TI products or services with statements different from or beyond the parameters stated by TI for that product or service voids all express and any implied warranties for the associated TI product or service and is an unfair and deceptive business practice. TI is not responsible or liable for any such statements.

TI products are not authorized for use in safety-critical applications (such as life support) where a failure of the TI product would reasonably be expected to cause severe personal injury or death, unless officers of the parties have executed an agreement specifically governing such use. Buyers represent that they have all necessary expertise in the safety and regulatory ramifications of their applications, and acknowledge and agree that they are solely responsible for all legal, regulatory and safety-related requirements concerning their products and any use of TI products in such safety-critical applications, notwithstanding any applications-related information or support that may be provided by TI. Further, Buyers must fully indemnify TI and its representatives against any damages arising out of the use of TI products in such safety-critical applications.

TI products are neither designed nor intended for use in military/aerospace applications or environments unless the TI products are specifically designated by TI as military-grade or "enhanced plastic." Only products designated by TI as military-grade meet military specifications. Buyers acknowledge and agree that any such use of TI products which TI has not designated as military-grade is solely at the Buyer's risk, and that they are solely responsible for compliance with all legal and regulatory requirements in connection with such use.

TI products are neither designed nor intended for use in automotive applications or environments unless the specific TI products are designated by TI as compliant with ISO/TS 16949 requirements. Buyers acknowledge and agree that, if they use any non-designated products in automotive applications, TI will not be responsible for any failure to meet such requirements.

Following are URLs where you can obtain information on other Texas Instruments products and application solutions:

### Products

Audio	<a href="http://www.ti.com/audio">www.ti.com/audio</a>
Amplifiers	<a href="http://amplifier.ti.com">amplifier.ti.com</a>
Data Converters	<a href="http://dataconverter.ti.com">dataconverter.ti.com</a>
DLP® Products	<a href="http://www.dlp.com">www.dlp.com</a>
DSP	<a href="http://dsp.ti.com">dsp.ti.com</a>
Clocks and Timers	<a href="http://www.ti.com/clocks">www.ti.com/clocks</a>
Interface	<a href="http://interface.ti.com">interface.ti.com</a>
Logic	<a href="http://logic.ti.com">logic.ti.com</a>
Power Mgmt	<a href="http://power.ti.com">power.ti.com</a>
Microcontrollers	<a href="http://microcontroller.ti.com">microcontroller.ti.com</a>
RFID	<a href="http://www.ti-rfid.com">www.ti-rfid.com</a>
OMAP Mobile Processors	<a href="http://www.ti.com/omap">www.ti.com/omap</a>
Wireless Connectivity	<a href="http://www.ti.com/wirelessconnectivity">www.ti.com/wirelessconnectivity</a>

### Applications

Automotive and Transportation	<a href="http://www.ti.com/automotive">www.ti.com/automotive</a>
Communications and Telecom	<a href="http://www.ti.com/communications">www.ti.com/communications</a>
Computers and Peripherals	<a href="http://www.ti.com/computers">www.ti.com/computers</a>
Consumer Electronics	<a href="http://www.ti.com/consumer-apps">www.ti.com/consumer-apps</a>
Energy and Lighting	<a href="http://www.ti.com/energy">www.ti.com/energy</a>
Industrial	<a href="http://www.ti.com/industrial">www.ti.com/industrial</a>
Medical	<a href="http://www.ti.com/medical">www.ti.com/medical</a>
Security	<a href="http://www.ti.com/security">www.ti.com/security</a>
Space, Avionics and Defense	<a href="http://www.ti.com/space-avionics-defense">www.ti.com/space-avionics-defense</a>
Video and Imaging	<a href="http://www.ti.com/video">www.ti.com/video</a>

TI E2E Community Home Page

[e2e.ti.com](http://e2e.ti.com)

Mailing Address: Texas Instruments, Post Office Box 655303, Dallas, Texas 75265  
Copyright © 2012, Texas Instruments Incorporated