

APPLICATION NOTE

AN148

Audio amplifier with TDA1013A

Author: D. Udo

1991 Dec

Audio amplifier with TDA1013A

AN148

Author: D. Udo

ABSTRACT

The 9-pin SOT-110B-encapsulated TDA1013A is an audio power amplifier that has a DC volume control on-board. The device is designed for audio amplifier applications in TV sound channels.

At a supply voltage of 18V, the output power is about 4.4W into an 8Ω loudspeaker.

The gain control range is >80dB with a DC control voltage from 8 to 3.5V.

Some basic information of the TDA1013A is dealt with in this application note. Detailed performance properties are given for an 18V into 8Ω application.

INTRODUCTION

The TDA1013A has two functions: a DC volume control and audio power amplifier.

Some performance characteristics are:

- Supply voltage range 15-35V
- Max. repetitive peak current 1.5A
- Max. non-repetitive peak current 3A
- θJTAB 9°C
- θJA 45°C
- Input impedance 100kΩ (Pins 5 and 8)
- Output impedance 200Ω (Pin 6) (typ.)
- Voltage gain DC control part 7dB (Pins 8 to 6)
- Voltage gain power amplifier 30dB (Pins 5 to 2)

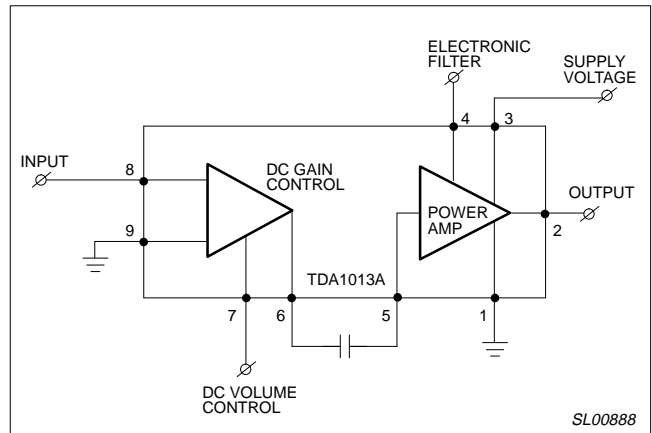

Figure 1.

APPLICATION CIRCUIT

The complete application circuit is given in Figure 1. With high input impedance, C₉ is necessary to filter-out RF input interferences. R₃ in combination with C₅ is used to limit the AF frequency bandwidth. The 470μF power supply decoupling capacitor is C₁₀.

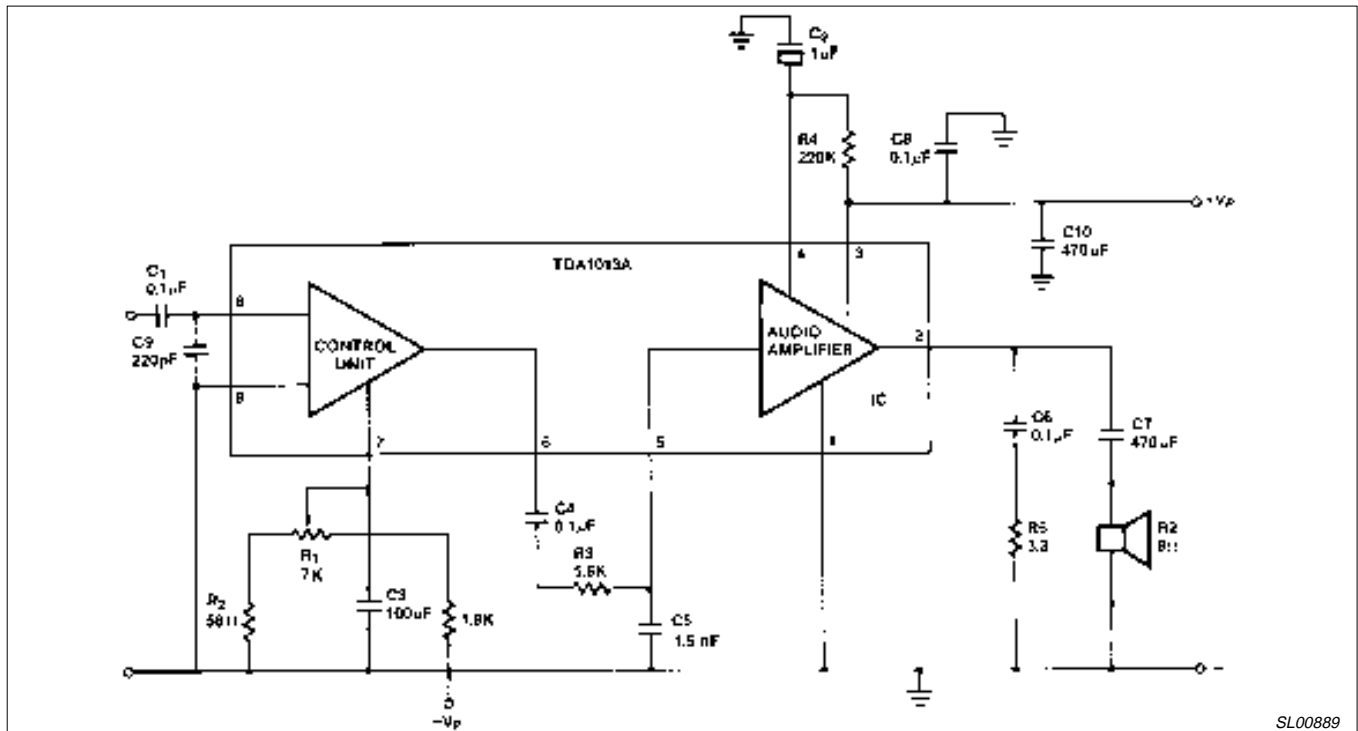

Figure 2. Block Diagram and External Components

Audio amplifier with TDA1013A

AN148

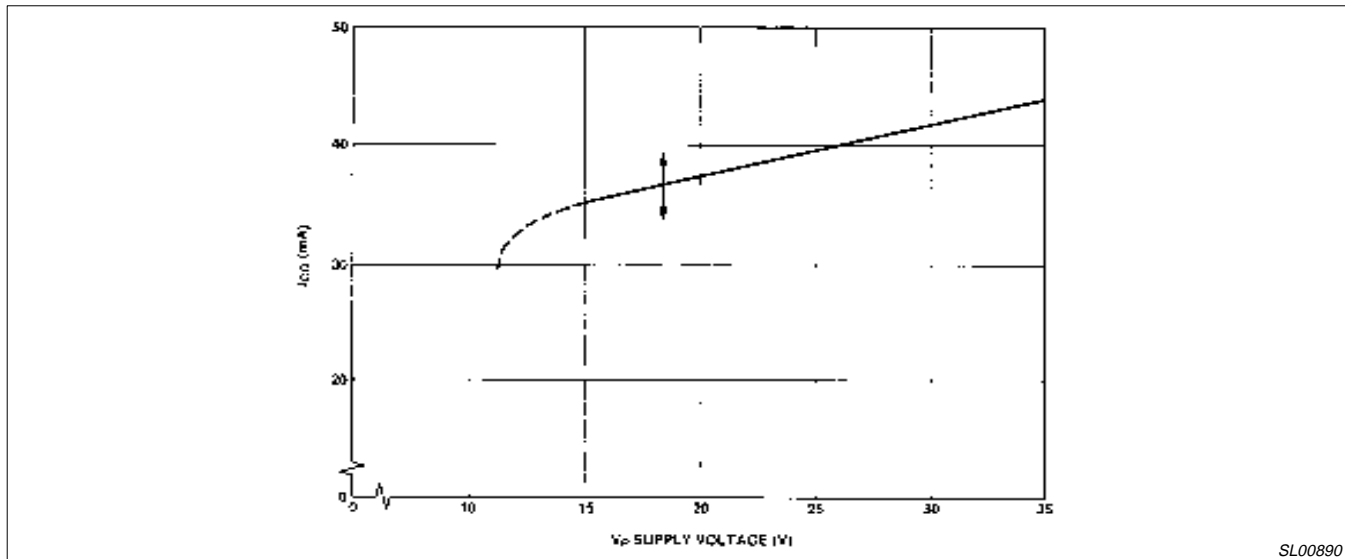

Figure 3. Quiescent Current vs V_{CC}

SL00890

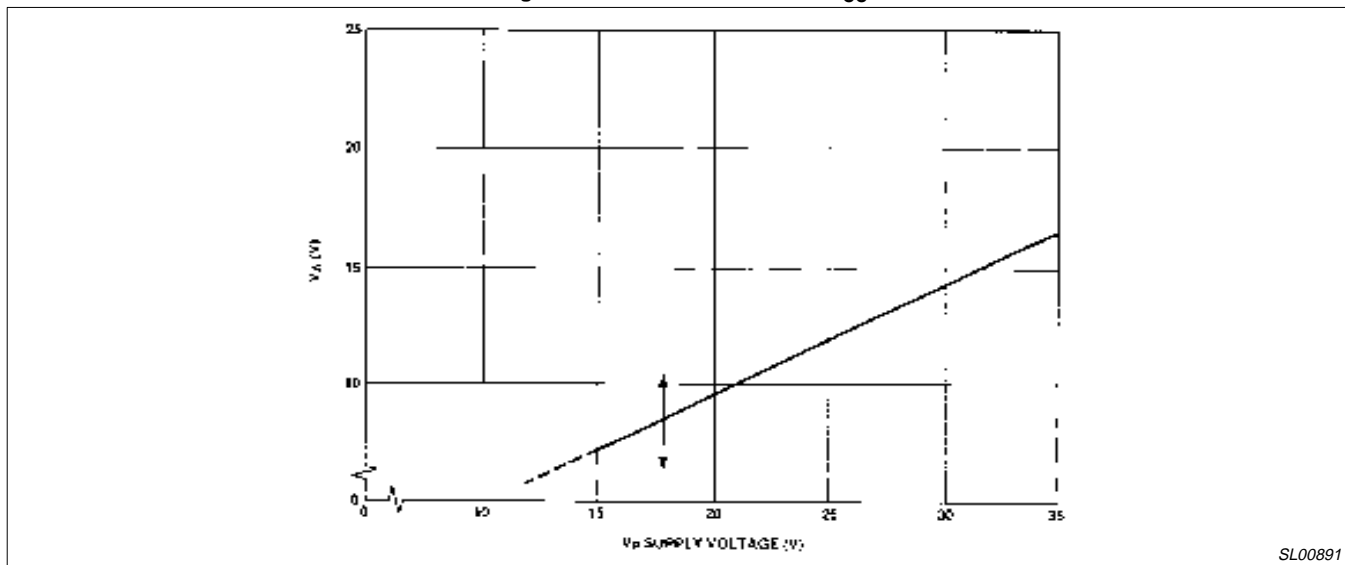

Figure 4. Midtap Voltage vs V_{CC}

SL00891

MEASUREMENTS

Various measurements made in the circuit of Figure 1 are given. If not otherwise stated, the measurements are done at $V_{CC}=18V$, $R_L=8\Omega$, $f=1kHz$ and $T_A=25^\circ C$.

Quiescent Current Consumption

The quiescent current as a function of V_{CC} is given in Figure 3. At $V_{CC}=18V$ the maximum spread on 20 samples is indicated by arrows.

Midtap Voltage

The midtap voltage V_A versus V_{CC} at output Pin 2 is shown in Figure 4.

Output Power and Dissipation

The output power for $d=10\%$ as a function of V_{CC} at Pin 2 and across the 8Ω loudspeaker load is given in Figure 5. The upper curve gives

the worst-case sinewave dissipation. The dissipation versus output power for $V_{CC}=18V$ is given in Figure 6.

Distortion

The total harmonic distortion as a function of P_O is shown in Figure 7 for signal frequencies of 1 and 10kHz (DC control voltage at Pin 7 is constant 8V). In Figure 8 the same curve is given for $f=1kHz$ but now the output power is reduced by the DC control voltage (at $d=10\% V_{DC}$ Pin 7=8V). The distortion for 2.5W output power versus frequency is given in Figure 11. In Figure 9, the distortion of the DC gain-controlled preamplifier as a function of the signal excursion at Pin 6 is shown for a DC control voltage (V_{DC} Pin 7) of 8V. *4COL

Audio amplifier with TDA1013A

AN148

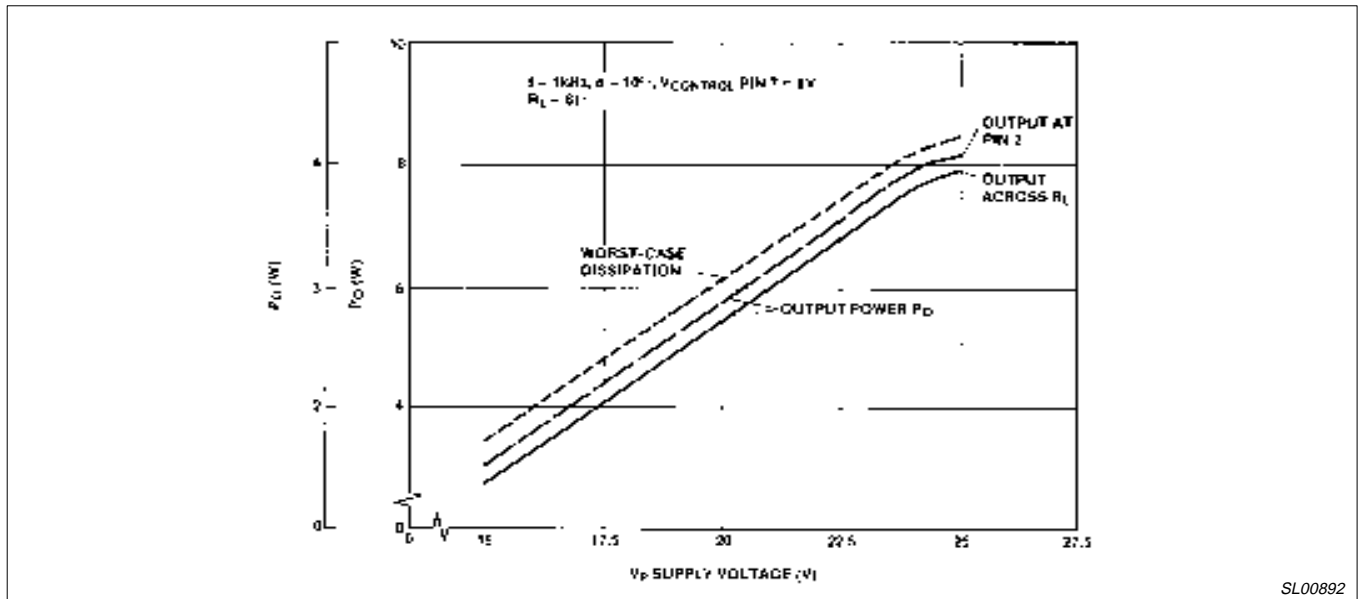

SL00892

Figure 5. Output Power and Dissipation vs V_{CC}

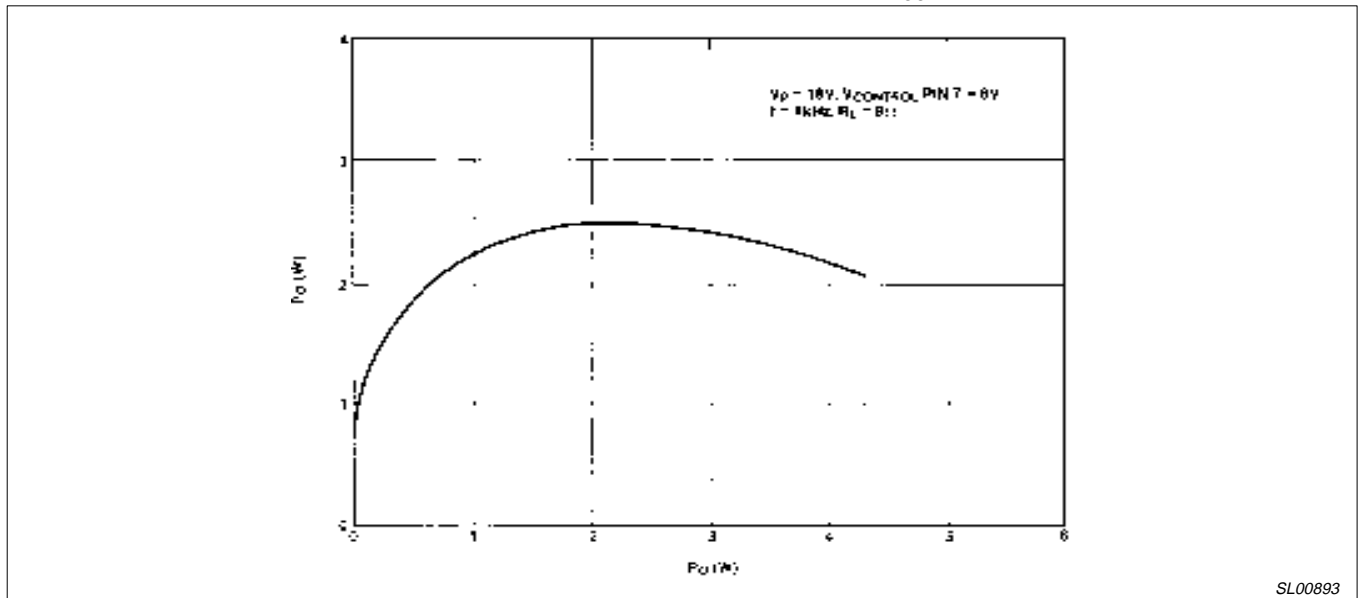

SL00893

Figure 6. Dissipation vs P_O

Audio amplifier with TDA1013A

AN148

Gain Control

The typical overall voltage gain (V_{DC} Pin 7=8V) is 38dB. The gain control curve versus the DC control voltage on Pin 7 is shown in Figure 10.

Frequency Characteristic

The frequency characteristic is presented in Figure 12. The -3dB bandwidth is from 32Hz to 20kHz.

Power Bandwidth

The power bandwidth ($d=10\%$) is given in Figure 13. The low frequency behavior is determined by the value of the output electrolytic C_7 .

Supply Voltage Ripple Rejection

The supply voltage ripple rejection versus frequency is shown in Figure 14 for $R_S=0$ and $10k\Omega$. Ripple voltage on Pin 3 is $500mV_{RMS}$.

Noise Behavior

The A-weighted, IEC 179 standard, signal-to-noise ratio at maximum gain (V_{DC} Pin 7=8V) is 68dB at $R_S=0\Omega$ and related to $P_O=2.5W$. Increasing R_S has hardly any influence on this noise level. Typical S/N is 74dB.

CONCLUSION

The TDA1013A is a suitable IC as an audio amplifier in TV receivers. It delivers an output power of about 4.4W in $R_L=8\Omega$ at $V_{CC}=18V$. An 80dB DC gain control is incorporated.

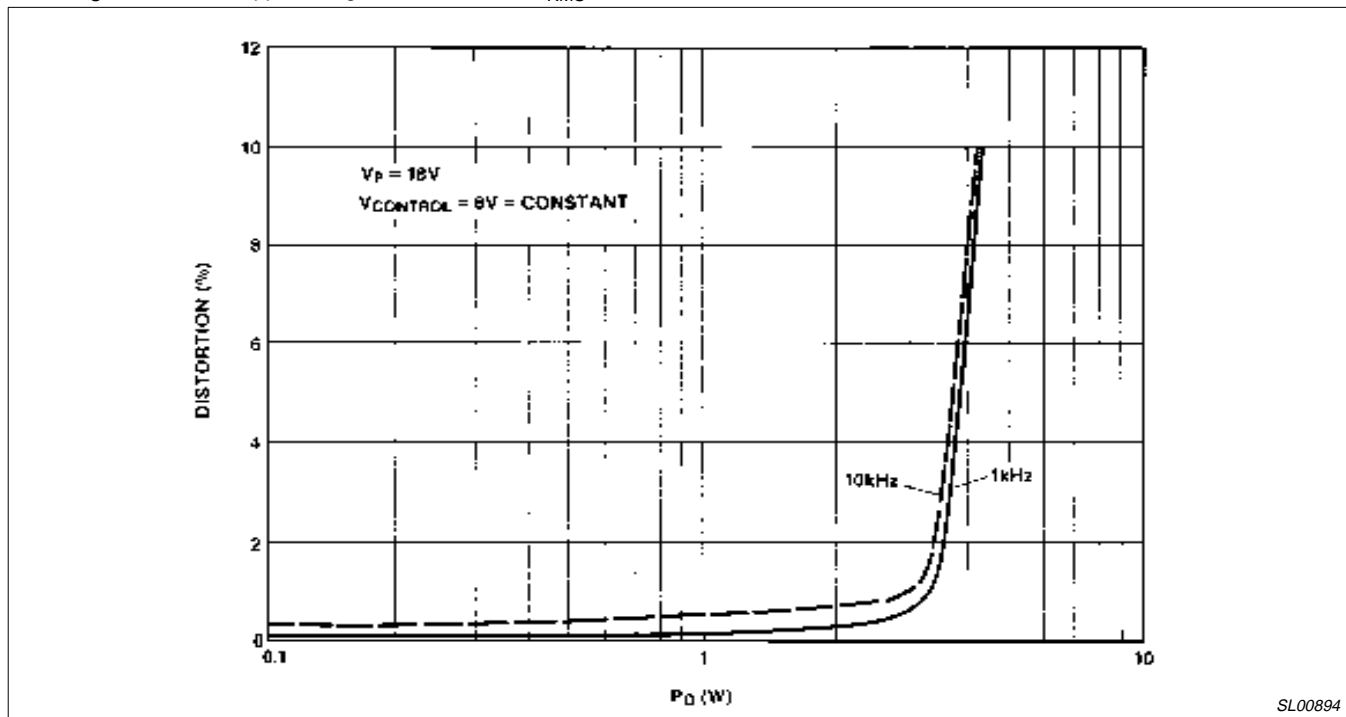

Figure 7. Distortion vs P_O

Audio amplifier with TDA1013A

AN148

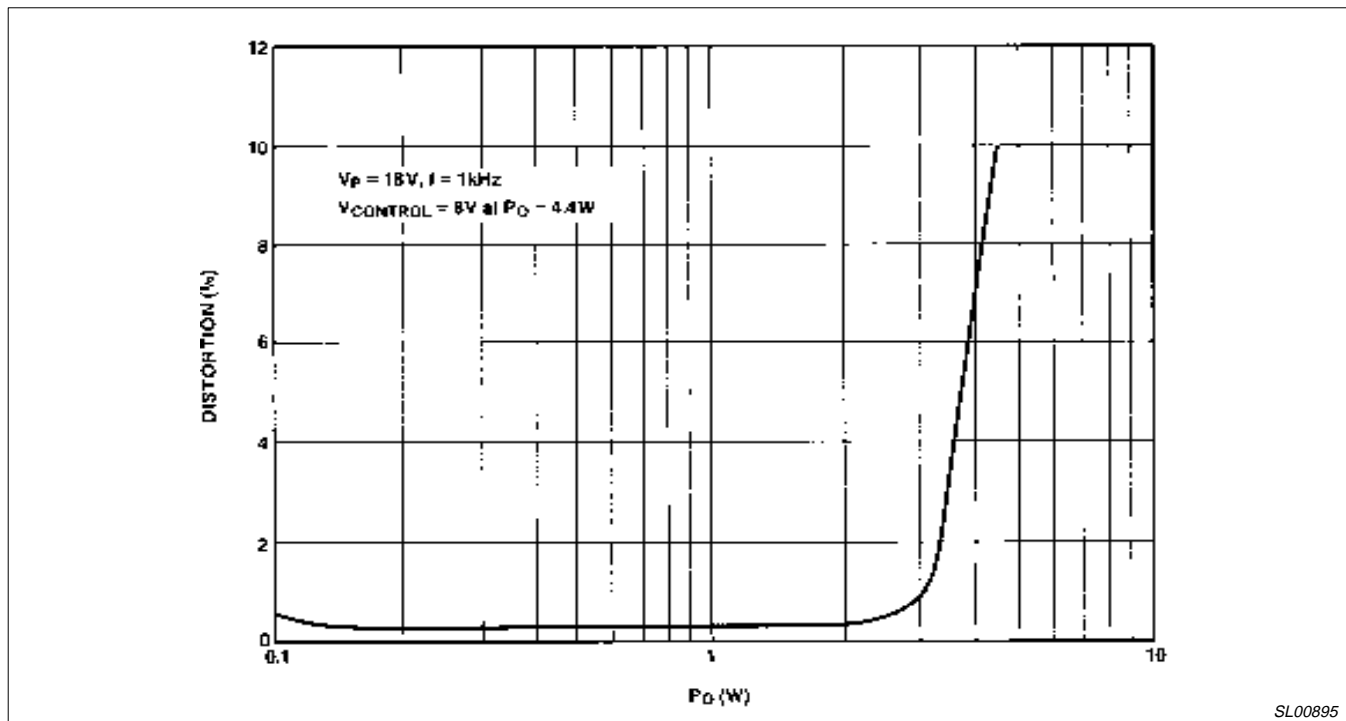

Figure 8.

Audio amplifier with TDA1013A

AN148

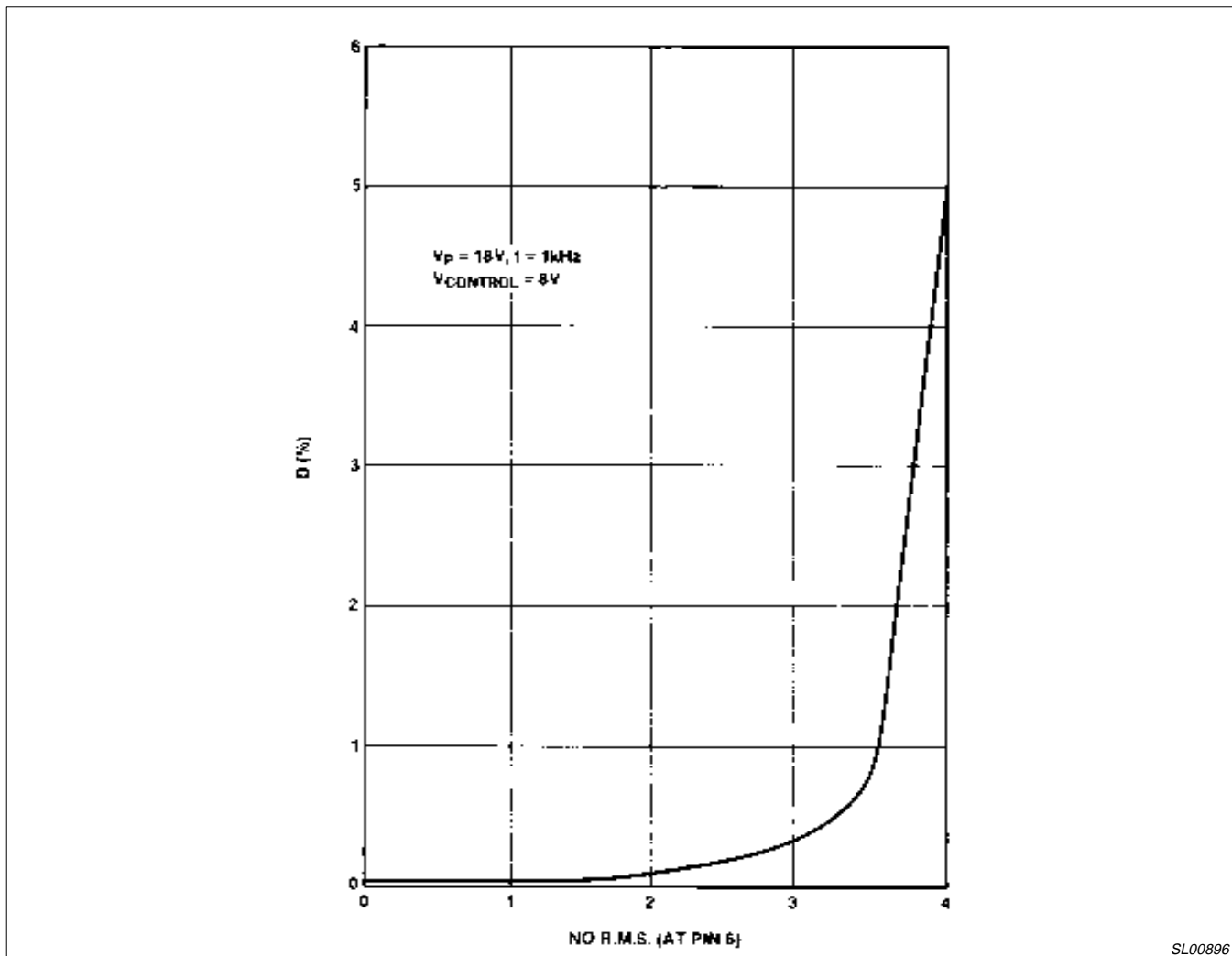

Figure 9. Distortion of Control Amplifier at Pin 6

SL00896

Audio amplifier with TDA1013A

AN148

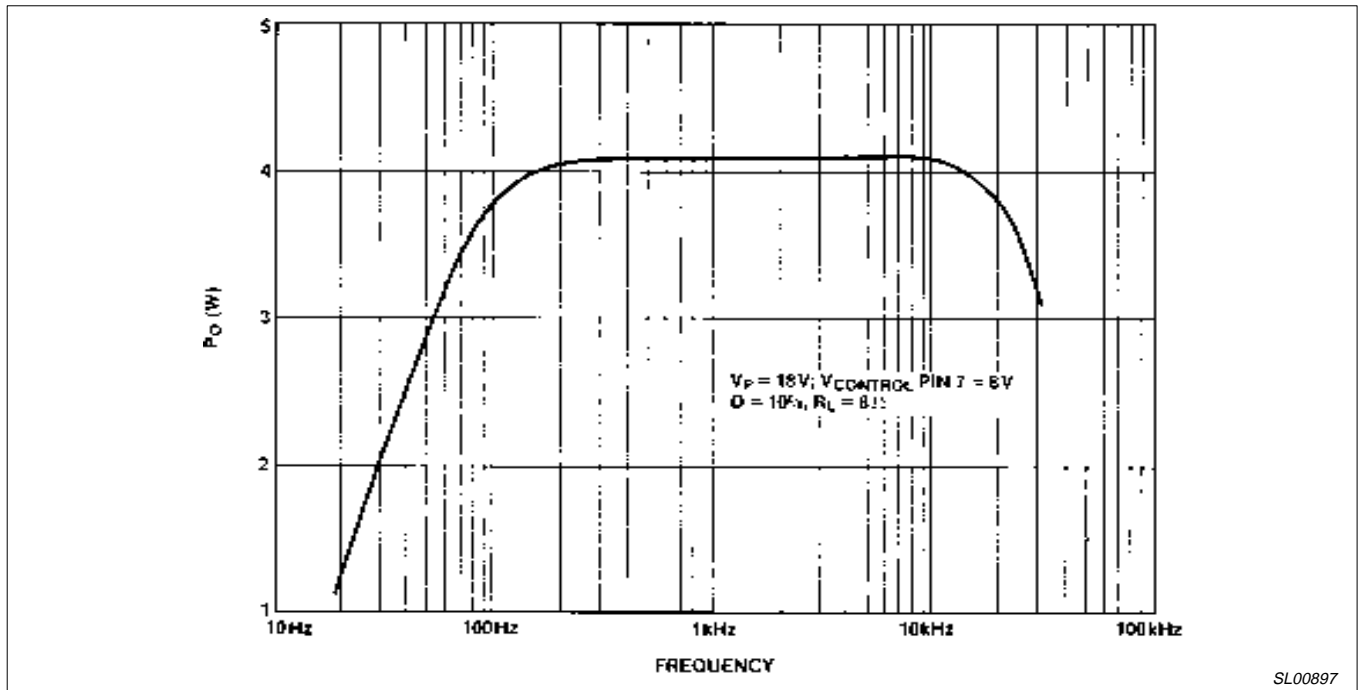

Figure 10. Typical Control Curve DC Control Voltage at Pin 7

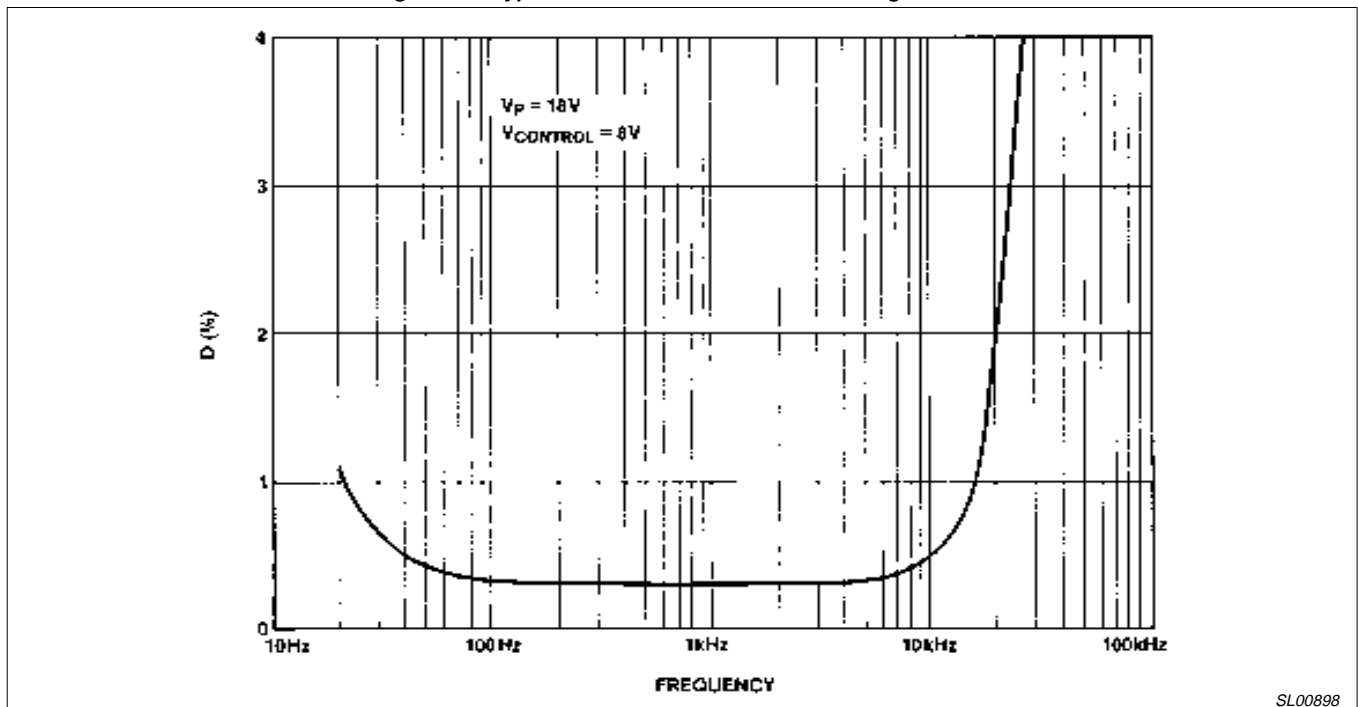

Figure 11. Distortion at $P_o = 2.5W$ vs Frequency (At Pin 2 of IC)

Audio amplifier with TDA1013A

AN148

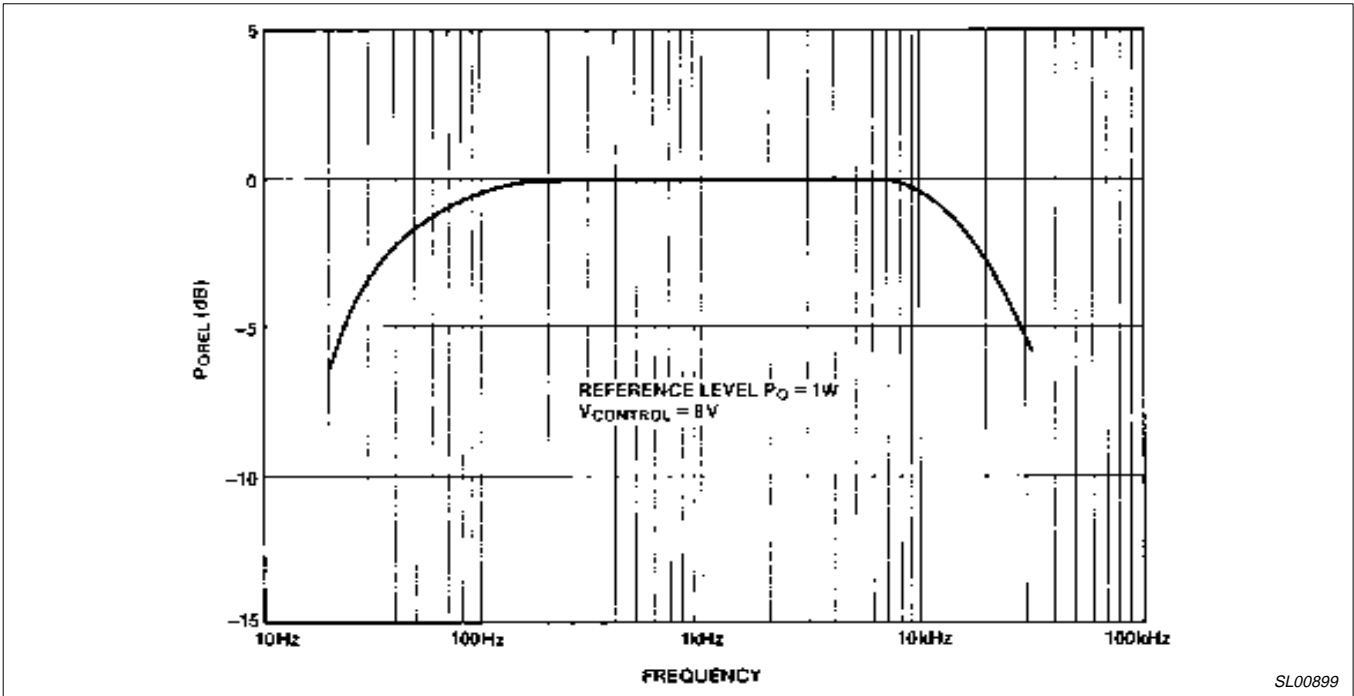

Figure 12. Frequency Characteristic

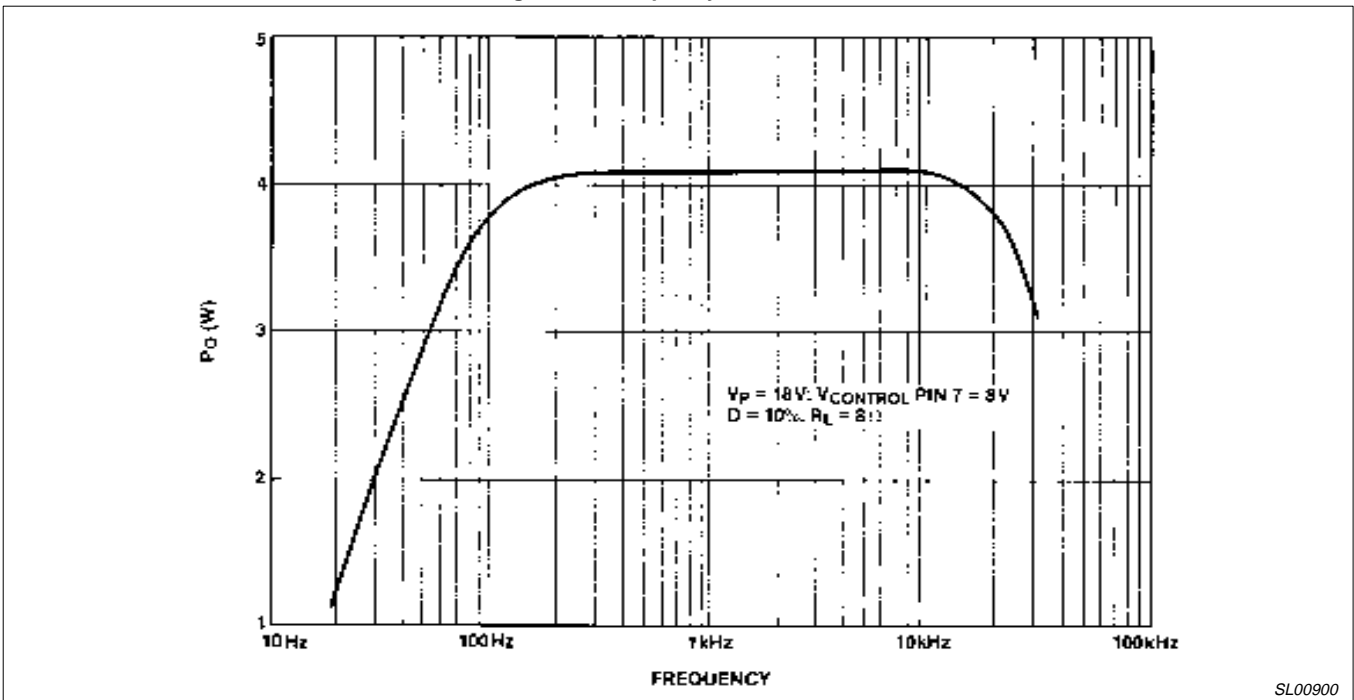

Figure 13. Power Bandwidth

Audio amplifier with TDA1013A

AN148

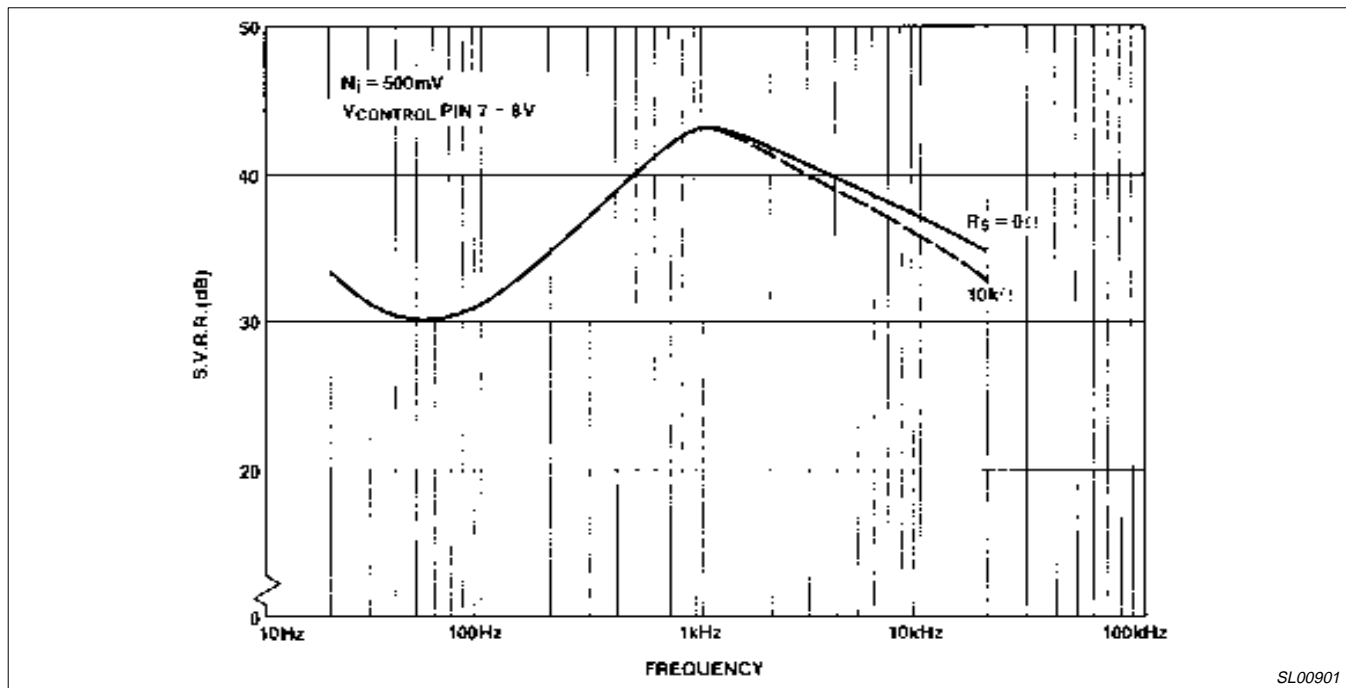

Figure 14. Ripple Rejection vs Frequency

SL00901