

# TA8251AHQ

## Max Power 30W BTL × 4ch Audio Power IC

The TA8251AHQ is 4ch BTL audio power amplifier for consumer application.

It is designed low distortion ratio for 4ch BTL audio power amplifier, built-in stand-by function, muting function and junction temperature detection circuit. Additionally, the AUX. amplifier is built-in, it can make the beep signal etc. Output to 2 channels (out1 and 4).

It contains various kind of protectors for car audio.

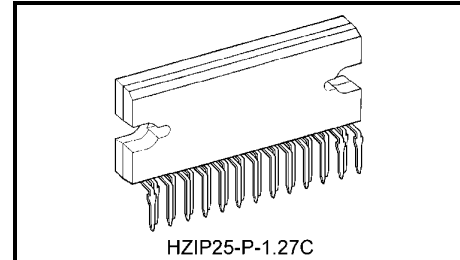

Weight: 9.8g (typ.)

### Features

- High power
  - : P<sub>OUT</sub> (max) = 30W (typ.)  
(V<sub>CC</sub> = 13.7V, f = 1kHz, R<sub>L</sub> = 4Ω)
  - : P<sub>OUT</sub> (1) = 21W (typ.)  
(V<sub>CC</sub> = 14.4V, f = 1kHz, THD = 10%, R<sub>L</sub> = 4Ω)
  - : P<sub>OUT</sub> (2) = 18W (typ.)  
(V<sub>CC</sub> = 13.2V, f = 1kHz, THD = 10%, R<sub>L</sub> = 4Ω)
- Low distortion ratio
  - : THD = 0.02% (typ.)  
(V<sub>CC</sub> = 13.2V, f = 1kHz, P<sub>OUT</sub> = 3W, R<sub>L</sub> = 4Ω)
- Low noise
  - : V<sub>NO</sub> = 0.10mV<sub>rms</sub> (typ.)  
(V<sub>CC</sub> = 13.2V, R<sub>g</sub> = 0Ω, G<sub>V</sub> = 34dB, BW = 20~20kHz)
- Built-in stand-by switch function (pin(2))
- Built-in muting function (pin(1), (25))
- Built-in AUX. amplifier from single input to 2 channels output (pin(16))
- Built-in junction temperature detection circuit (pin(24))
  - : Pin(24) DC voltage rises at about +10mV / °C in proportion to junction temperature.
- Built-in various protection circuit
  - : Thermal shut down, Over voltage, Out to GND, Out to V<sub>CC</sub>, Out to Out short
- Operating supply voltage
  - : V<sub>CC</sub> (opr) = 9~18V

**Block Diagram**

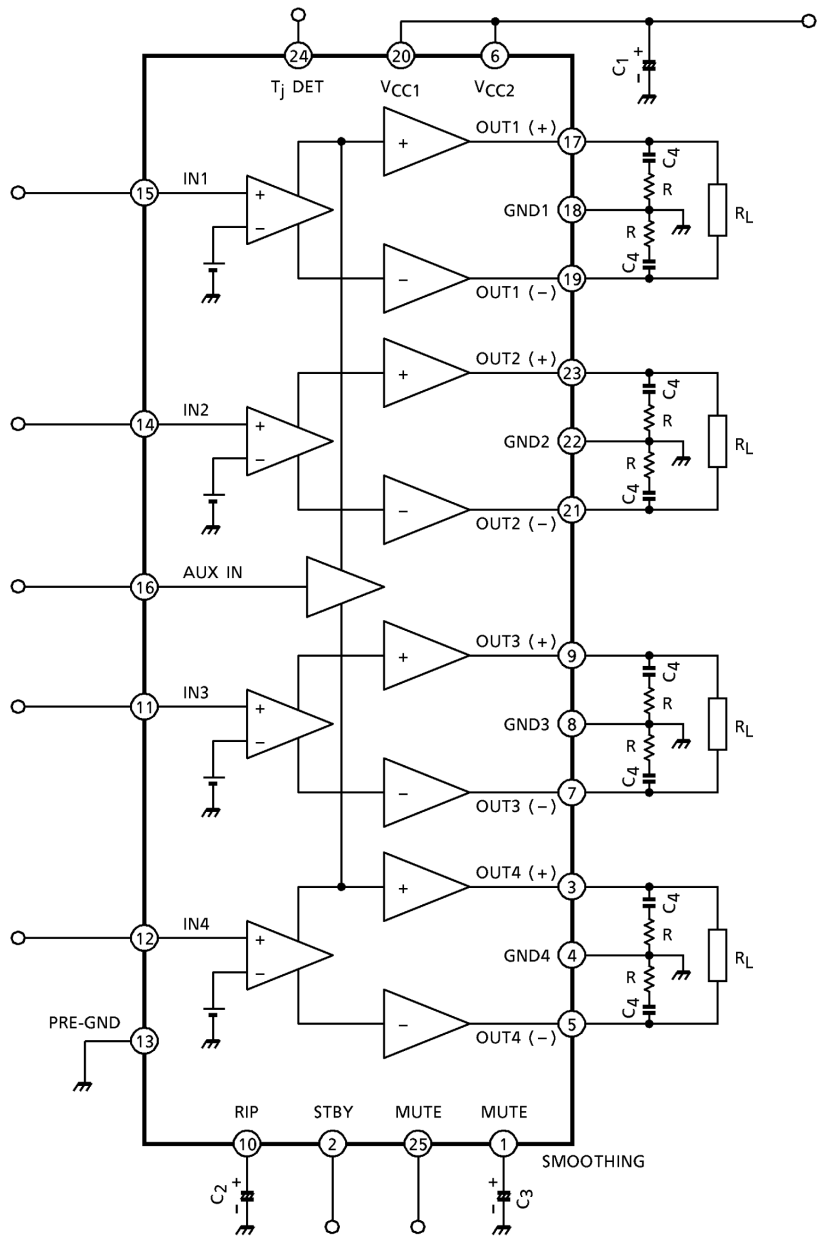

**Caution And Application Method**  
(description is made only on the single channel.)

1. Voltage gain adjustment

This IC has no NF (negative feedback) terminals. Therefore, the voltage gain can't adjusted, but it makes the device a space and total costs saver.

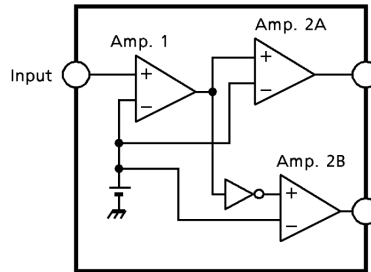

(Fig.1) Block diagram

The voltage gain of amp. 1:  $G_{V1} = 0\text{dB}$

The voltage gain of amp. 2A, B:  $G_{V2} = 28\text{dB}$

The voltage gain of BTL connection:  $G_V (\text{BTL}) = 6\text{dB}$

Therefore, the total voltage gain is decided by expression below.

$$G_V = G_{V1} + G_{V2} + G_V (\text{BTL}) = 0 + 28 + 6 = 34\text{dB}$$

2. Stand-by SW function

By means of controlling pin(2) (stand-by terminal) to high and low, the power supply can be set to on and off. The threshold voltage of pin(2) is set at about 3V (typ.), and the power supply current is about 100 $\mu\text{A}$  (typ.) at the stand-by state.

Control voltage of pin(2): V (SB)

Stand-By	Power	V (SB) (V)
On	Off	0~2
Off	On	3~V <sub>CC</sub>

Adjustage of stand-by SW

- (1) Since V<sub>CC</sub> can directly be controlled to on or off by the microcomputer, the switching relay can be omitted.
- (2) Since the control current is microscopic the switching relay of small current capacity is satisfactory for switching

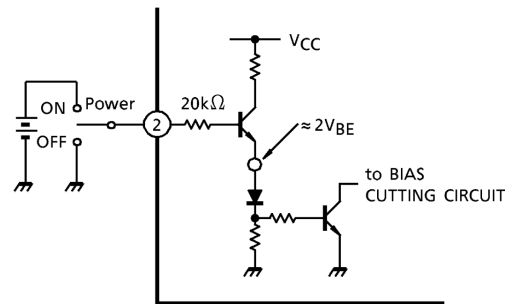

(Fig.2) With pin② set to High, Power is turned ON

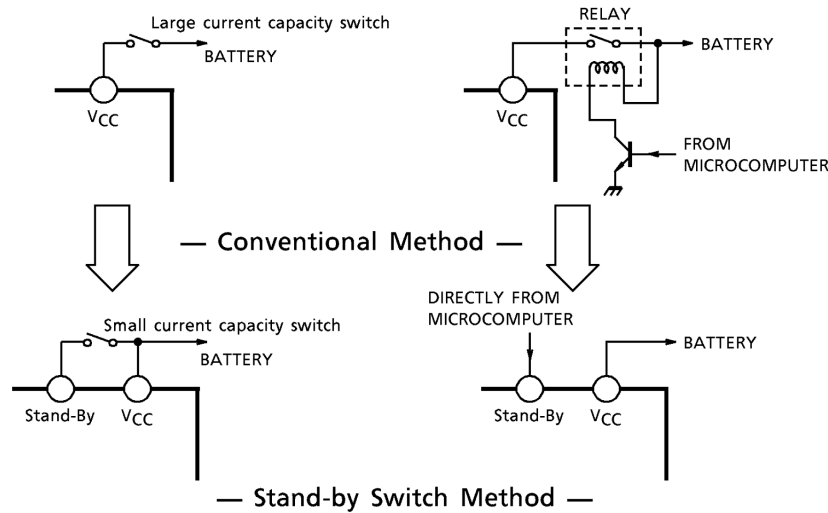

3. Preventive measure against oscillation

For preventing the oscillation, it is advisable to use C<sub>4</sub>, the condenser of polyester film having small characteristic fluctuation of the temperature and the frequency.

The resistance R to be series applied to C<sub>4</sub> is effective for phase correction of high frequency, and improves the oscillation allowance.

- (1) Capacity value and the kind of condenser
- (2) Layout of printed board

4. Junction temperature detecting pin(24)

Using temperature characteristic of a band gap circuit and in proportion to junction temperature, pin(24) DC voltage: V<sub>2</sub> rises at about +10mV / °C temperature characteristic. So, the relation between V<sub>2</sub> at T<sub>j</sub> = 25°C and V<sub>2x</sub> at T<sub>j</sub> = x°C is decided by the following expression:

$$T(x^{\circ}\text{C}) = \frac{V_{2x} - V_2(25^{\circ}\text{C})}{10\text{mV} / ^{\circ}\text{C}} + 25 (^{\circ}\text{C})$$

In deciding a heat sink size, a junction temperature can be easily made clear by measuring voltage at this pin while a backside temperature of IC was so far measured using a thermocouple type thermometer.

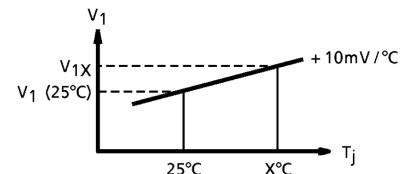

(Fig.3)

5. Muting function: Pin(1), pin(25)

By means of controlling pin(25) (mute control terminal) less than about 1.5V, it can make the IC muting condition as below. However, pin(25) must not be connected to a certain voltage, for example, VCC, VDD, Vref, ... etc. In other words, pin(25) is inhibited to be pulled up, for instance fig. 5 application.

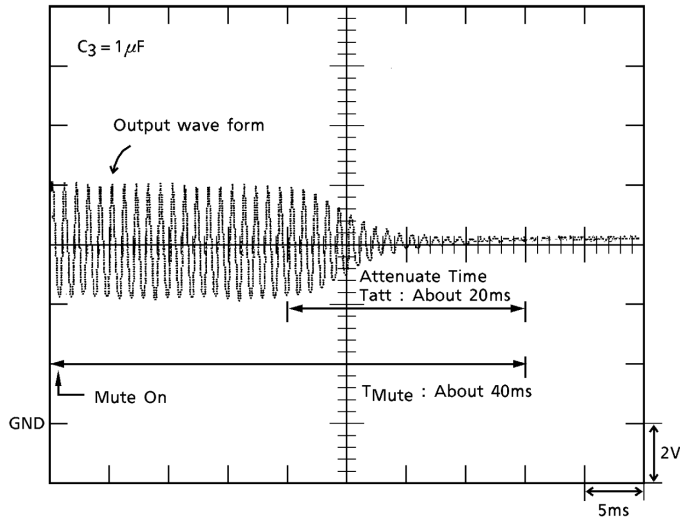

(Fig.4) Output wave form at Muting Condition

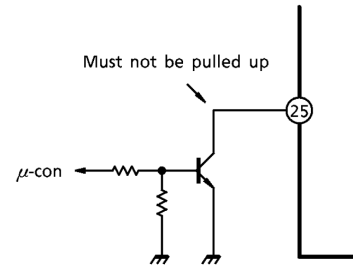

(Fig.5) Mute control

The attenuation by the muting function is 70dB (typ.). This muting is very smooth attenuating by the time constant of pin(1): smoothing.

Therefore, this function is suitable to the audio muting. The time for attenuation: Tatt is adjustable by changing the capacitance of C3. But the tatt may influence the popping noise level.

So, please decide the time of tatt by testing on the units.

6. AUX. amplifier: Pin(16)

The pin(16) is for input terminal of AUX. amplifier.

The total gain is 0dB by using of AUX. amplifier.

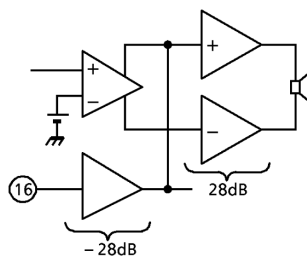

(Fig.6) AUX. amplifier

Therefore, the μ-con can directly drive the AUX. amplifier.

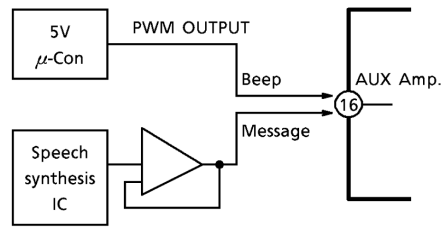

(Fig.7) The application of AUX. amplifier

The amplified signal from pin(16) is out to the out1 and 4.

7. Cross talk

The cross talk characteristics of the IC is not good between out1 and 2, out3 and 4. So we recommend to use by below method.

Out1, 2	L-ch (or R-ch)
Out3, 4	R-ch (or L-ch)

And, please refer to below table in case of applying the AUX. in because it is out to out1 and 4.

ex)

Out1	Front	L-ch (or R-ch)	AUX. out
Out2	Rear		—
Out3	Rear	R-ch (or L-ch)	—
Out4	Front		AUX. out

## Absolute Maximum Ratings (Ta = 25°C)

Characteristic	Symbol	Rating	Unit
Peak supply voltage (0.2s)	V <sub>CC</sub> (surge)	50	V
DC supply voltage	V <sub>CC</sub> (DC)	25	V
Operating supply voltage	V <sub>CC</sub> (opr)	18	V
Output current (peak)	I <sub>o</sub> (peak)	9	A
Power dissipation	P <sub>D</sub> (*)	83	W
Operating temperature	T <sub>opr</sub>	-40~85	°C
Storage temperature	T <sub>stg</sub>	-55~150	°C

(\*) Package thermal resistance  $\theta_{j-T} = 15^{\circ}\text{C} / \text{W}$  (typ.)  
(Ta = 25°C, with infinite heat sink)

## Electrical Characteristics

(unless otherwise specified V<sub>CC</sub> = 13.2V, f = 1kHz, R<sub>L</sub> = 4Ω, Ta = 25°C)

Characteristic	Symbol	Test Circuit	Test Condition	Min.	Typ.	Max.	Unit
Quiescent current	I <sub>CCQ</sub>	—	V <sub>IN</sub> = 0	—	200	400	mA
Output power	P <sub>OUT</sub> (max)	—	V <sub>CC</sub> = 13.7V, max power	—	30	—	W
	P <sub>OUT</sub> (1)	—	V <sub>CC</sub> = 14.4V, THD = 10%	—	21	—	
	P <sub>OUT</sub> (2)	—	THD = 10%	16	18	—	
Total harmonic distortion	THD	—	P <sub>OUT</sub> = 3W	—	0.02	0.2	%
Voltage gain	G <sub>V</sub>	—	V <sub>OUT</sub> = 0.775V <sub>rms</sub> (0dBm)	32	34	36	dB
Voltage gain ratio	ΔG <sub>V</sub>	—	V <sub>OUT</sub> = 0.775V <sub>rms</sub> (0dBm)	-1.0	0	1.0	dB
Output noise voltage	V <sub>NO</sub> (1)	—	R <sub>g</sub> = 0Ω, DIN45405	—	0.12	—	mV <sub>rms</sub>
	V <sub>NO</sub> (2)	—	R <sub>g</sub> = 0Ω, BW = 20Hz~20kHz	—	0.10	0.35	mV <sub>rms</sub>
Ripple rejection ratio	R.R.	—	f <sub>rip</sub> = 100Hz, R <sub>g</sub> = 620Ω V <sub>rip</sub> = 0.775V <sub>rms</sub> (0dBm)	40	55	—	dB
Cross talk	C.T.	—	R <sub>g</sub> = 620Ω, V <sub>OUT</sub> = 0.775V <sub>rms</sub> (0dBm)	—	75	—	dB
Output offset voltage	V <sub>OFFSET</sub>	—	—	-300	0	+300	mV
Input resistance	R <sub>IN</sub>	—	—	—	30	—	kΩ
Stand-by current	I <sub>SB</sub>	—	Stand-by condition	—	100	150	μA
Stand-by control voltage	V <sub>SB</sub> H	—	Power: On	3.0	—	V <sub>CC</sub>	V
	V <sub>SB</sub> L	—	Power: Off	0	—	1.5	
Mute control voltage (*)	V <sub>M</sub> H	—	Mute: Off	Open			V
	V <sub>M</sub> L	—	Mute: On	0	—	1.5	
Mute attenuation	ATT M	—	Mute: On	—	70	—	dB

(\*) Muting function must be controlled by open and low logic.  
This means that the mute control terminal: Pin(25) must not be pulled up.

## Test Circuit ( $G_V = 34\text{dB}$ )

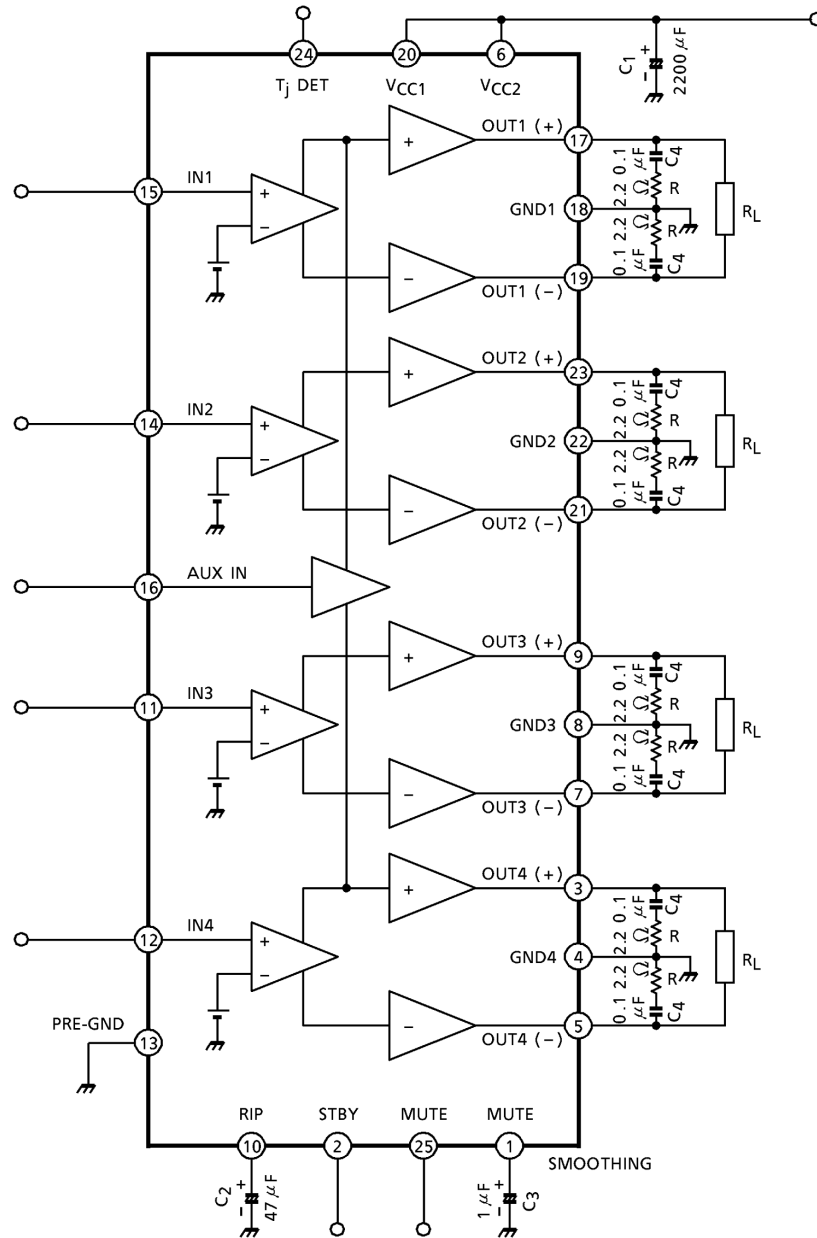



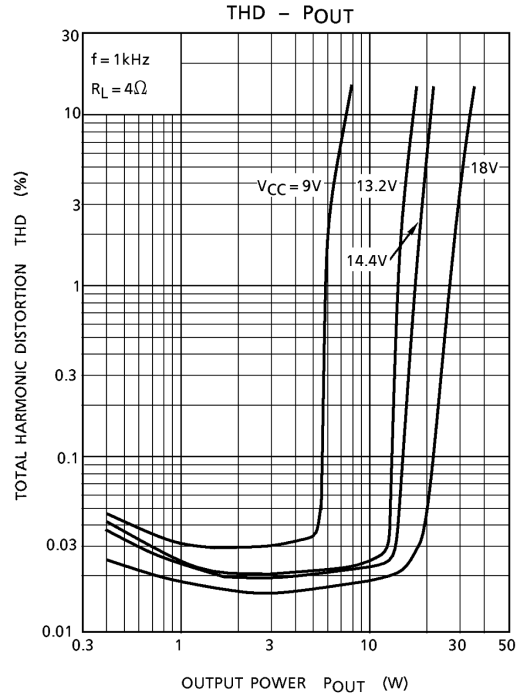
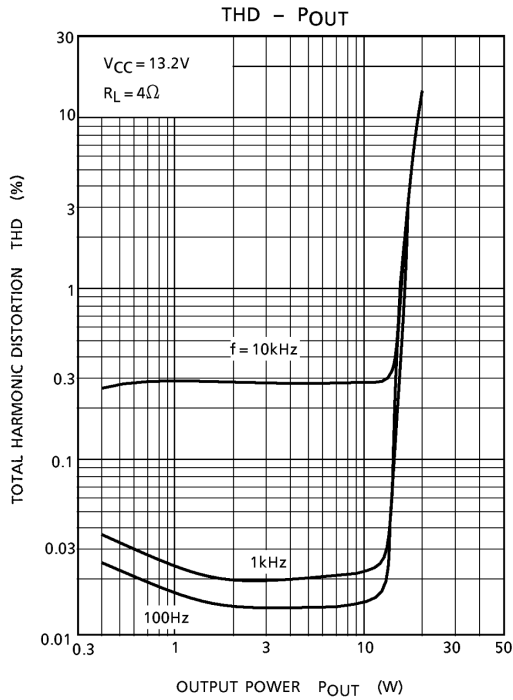
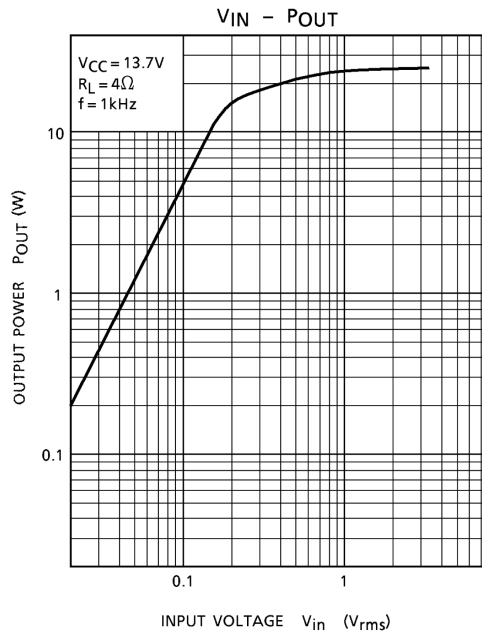
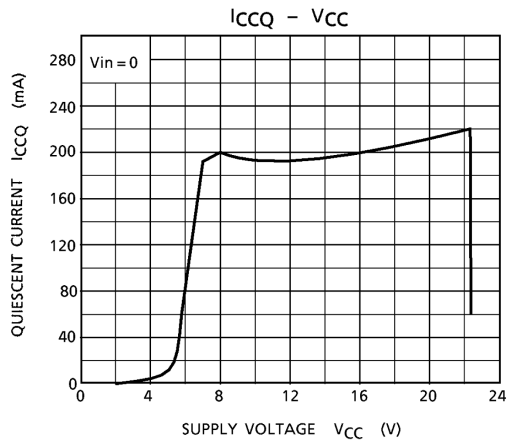

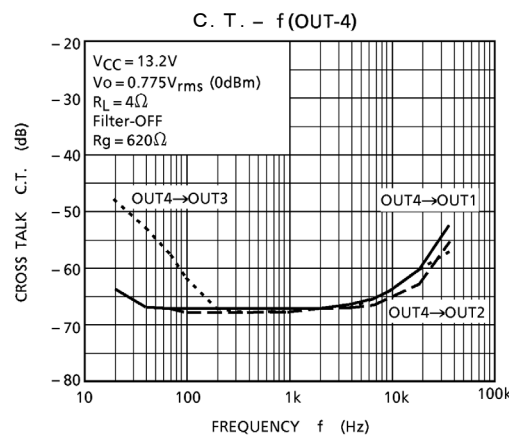
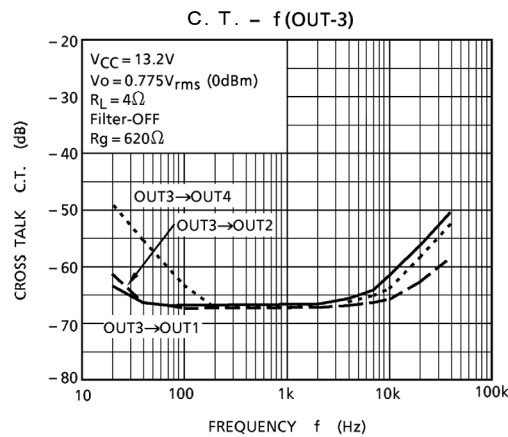
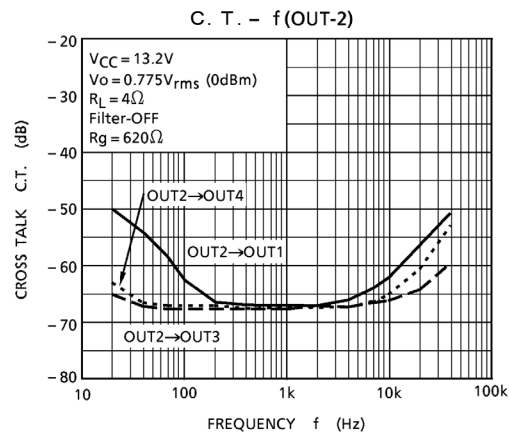
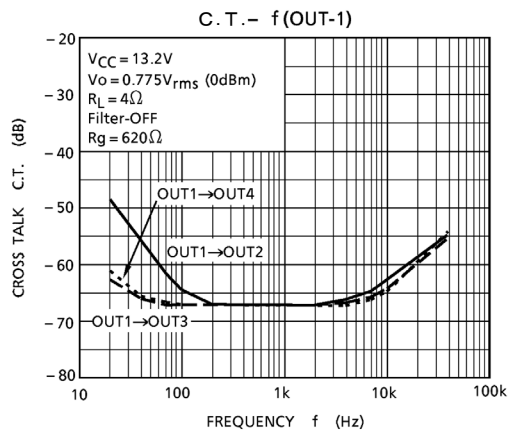
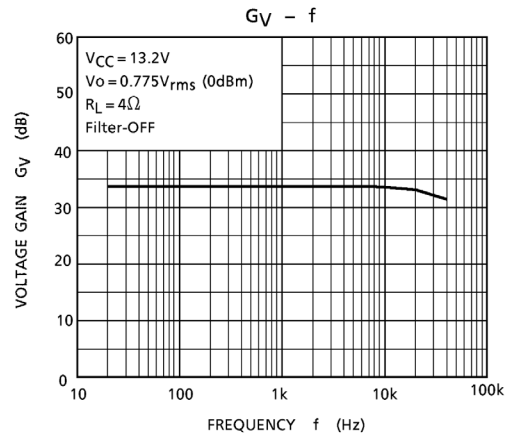
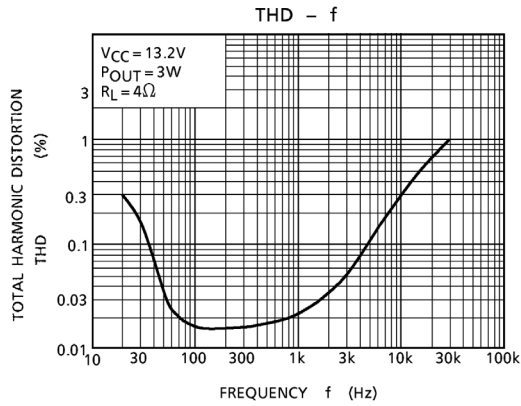

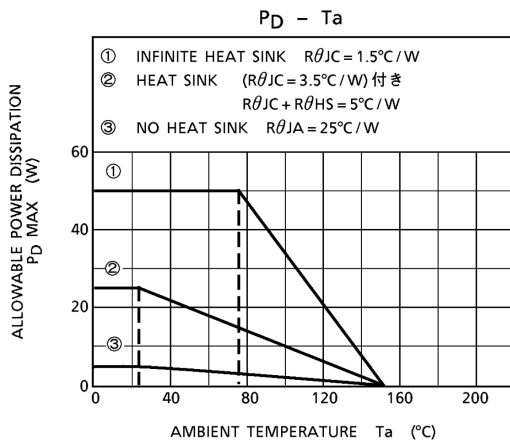
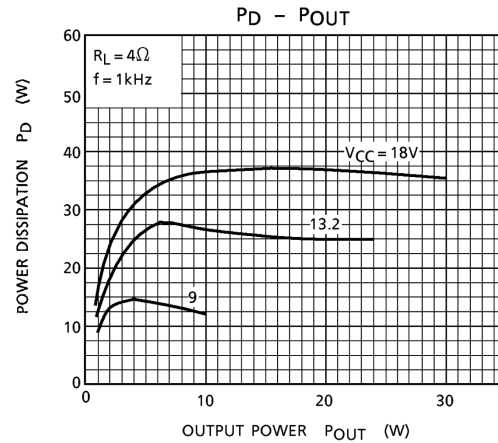
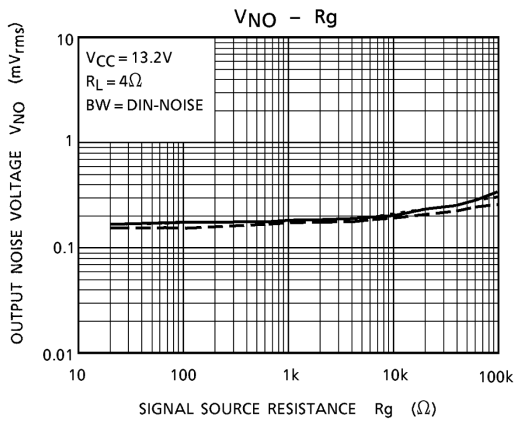
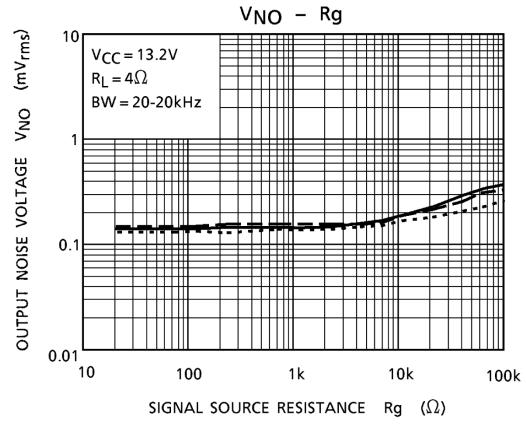
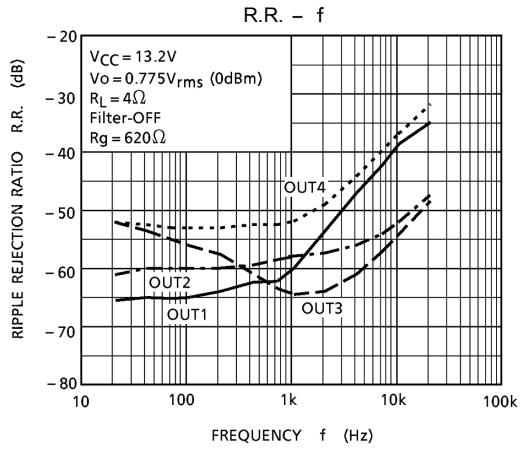

**Package Dimensions**

HZIP25-P-1.27C

Unit : mm

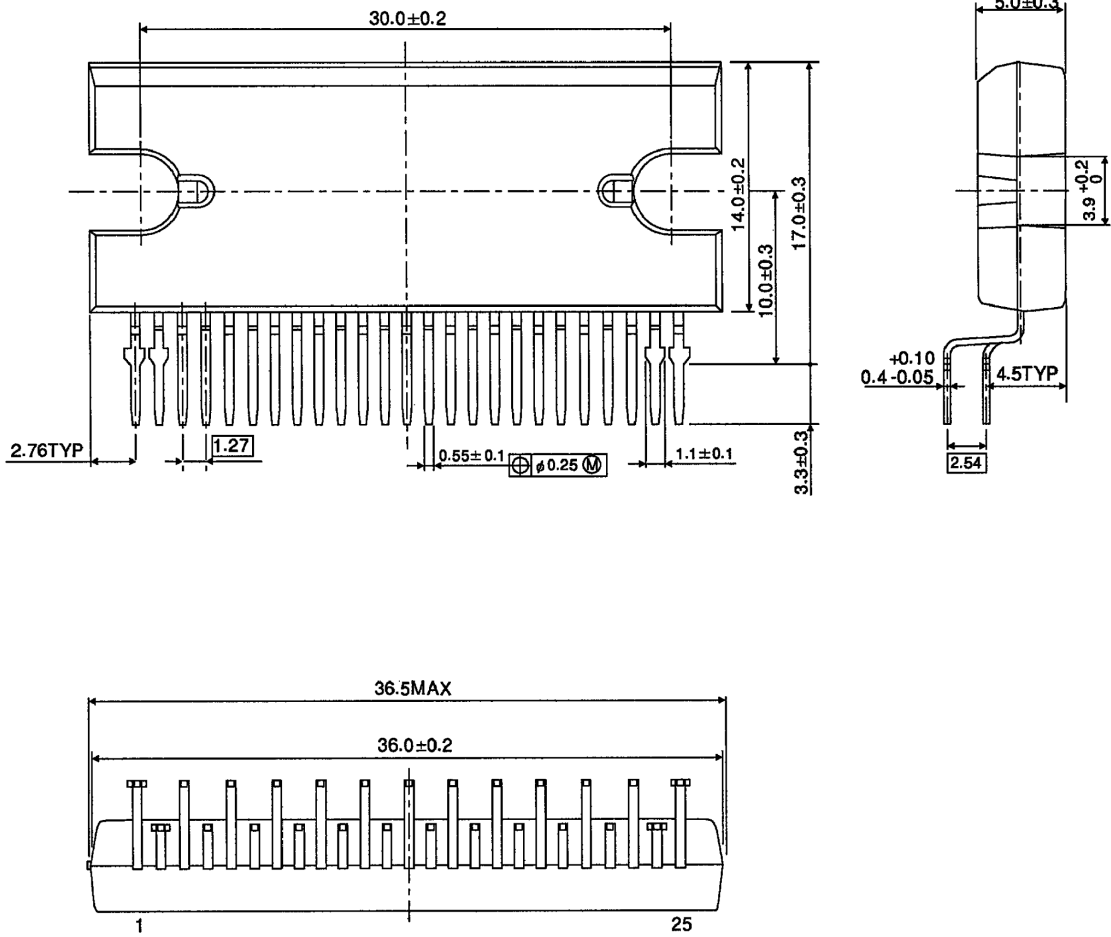

Weight: 9.8g (typ.)



- Use an appropriate power supply fuse to ensure that a large current does not continuously flow in case of over current and/or IC failure. The IC will fully break down when used under conditions that exceed its absolute maximum ratings, when the wiring is routed improperly or when an abnormal pulse noise occurs from the wiring or load, causing a large current to continuously flow and the breakdown can lead smoke or ignition. To minimize the effects of the flow of a large current in case of breakdown, appropriate settings, such as fuse capacity, fusing time and insertion circuit location, are required.
- If your design includes an inductive load such as a motor coil, incorporate a protection circuit into the design to prevent device malfunction or breakdown caused by the current resulting from the inrush current at power ON or the negative current resulting from the back electromotive force at power OFF. For details on how to connect a protection circuit such as a current limiting resistor or back electromotive force adsorption diode, refer to individual IC datasheets or the IC databook. IC breakdown may cause injury, smoke or ignition.
- Use a stable power supply with ICs with built-in protection functions. If the power supply is unstable, the protection function may not operate, causing IC breakdown. IC breakdown may cause injury, smoke or ignition.
- Carefully select external components (such as inputs and negative feedback capacitors) and load components (such as speakers), for example, power amp and regulator. If there is a large amount of leakage current such as input or negative feedback condenser, the IC output DC voltage will increase. If this output voltage is connected to a speaker with low input withstand voltage, overcurrent or IC failure can cause smoke or ignition. (The over current can cause smoke or ignition from the IC itself.) In particular, please pay attention when using a Bridge Tied Load (BTL) connection type IC that inputs output DC voltage to a speaker directly.
- Over current Protection Circuit  
Over current protection circuits (referred to as current limiter circuits) do not necessarily protect ICs under all circumstances. If the Over current protection circuits operate against the over current, clear the over current status immediately. Depending on the method of use and usage conditions, such as exceeding absolute maximum ratings can cause the over current protection circuit to not operate properly or IC breakdown before operation. In addition, depending on the method of use and usage conditions, if over current continues to flow for a long time after operation, the IC may generate heat resulting in breakdown.
- Thermal Shutdown Circuit  
Thermal shutdown circuits do not necessarily protect ICs under all circumstances. If the Thermal shutdown circuits operate against the over temperature, clear the heat generation status immediately. Depending on the method of use and usage conditions, such as exceeding absolute maximum ratings can cause the thermal shutdown circuit to not operate properly or IC breakdown before operation.
- Heat Radiation Design  
When using an IC with large current flow such as power amp, regulator or driver, please design the device so that heat is appropriately radiated, not to exceed the specified junction temperature ( $T_j$ ) at any time and condition. These ICs generate heat even during normal use. An inadequate IC heat radiation design can lead to decrease in IC life, deterioration of IC characteristics or IC breakdown. In addition, please design the device taking into considerate the effect of IC heat radiation with peripheral components.
- Installation to Heat Sink  
Please install the power IC to the heat sink not to apply excessive mechanical stress to the IC. Excessive mechanical stress can lead to package cracks, resulting in a reduction in reliability or breakdown of internal IC chip. In addition, depending on the IC, the use of silicon rubber may be prohibited. Check whether the use of silicon rubber is prohibited for the IC you intend to use, or not. For details of power IC heat radiation design and heat sink installation, refer to individual technical datasheets or IC databooks.

**RESTRICTIONS ON PRODUCT USE**

060116EBF

- The information contained herein is subject to change without notice. 021023\_D
- TOSHIBA is continually working to improve the quality and reliability of its products. Nevertheless, semiconductor devices in general can malfunction or fail due to their inherent electrical sensitivity and vulnerability to physical stress. It is the responsibility of the buyer, when utilizing TOSHIBA products, to comply with the standards of safety in making a safe design for the entire system, and to avoid situations in which a malfunction or failure of such TOSHIBA products could cause loss of human life, bodily injury or damage to property.  
In developing your designs, please ensure that TOSHIBA products are used within specified operating ranges as set forth in the most recent TOSHIBA products specifications. Also, please keep in mind the precautions and conditions set forth in the "Handling Guide for Semiconductor Devices," or "TOSHIBA Semiconductor Reliability Handbook" etc. 021023\_A
- The TOSHIBA products listed in this document are intended for usage in general electronics applications (computer, personal equipment, office equipment, measuring equipment, industrial robotics, domestic appliances, etc.). These TOSHIBA products are neither intended nor warranted for usage in equipment that requires extraordinarily high quality and/or reliability or a malfunction or failure of which may cause loss of human life or bodily injury ("Unintended Usage"). Unintended Usage include atomic energy control instruments, airplane or spaceship instruments, transportation instruments, traffic signal instruments, combustion control instruments, medical instruments, all types of safety devices, etc. Unintended Usage of TOSHIBA products listed in this document shall be made at the customer's own risk. 021023\_B
- The products described in this document shall not be used or embedded to any downstream products of which manufacture, use and/or sale are prohibited under any applicable laws and regulations. 060106\_Q
- The information contained herein is presented only as a guide for the applications of our products. No responsibility is assumed by TOSHIBA for any infringements of patents or other rights of the third parties which may result from its use. No license is granted by implication or otherwise under any patent or patent rights of TOSHIBA or others. 021023\_C
- The products described in this document are subject to the foreign exchange and foreign trade laws. 021023\_E
- This product generates heat during normal operation. However, substandard performance or malfunction may cause the product and its peripherals to reach abnormally high temperatures.  
The product is often the final stage (the external output stage) of a circuit. Substandard performance or malfunction of the destination device to which the circuit supplies output may cause damage to the circuit or to the product. 030619\_R

About solderability, following conditions were confirmed

- Solderability
  - (1) Use of Sn-37Pb solder Bath
    - solder bath temperature = 230°C
    - dipping time = 5 seconds
    - the number of times = once
    - use of R-type flux
  - (2) Use of Sn-3.0Ag-0.5Cu solder Bath
    - solder bath temperature = 245°C
    - dipping time = 5 seconds
    - the number of times = once
    - use of R-type flux