

SG6840 Data Sheet**DESCRIPTION**

This high-integrated PWM controller provides several special enhancements to satisfy the needs for low power standby and protection features. In standby mode, PWM frequency reduction is used to lower the power consumption and support a stable output voltage. Due to Bi-CMOS process, the SG6840 reduces start-up and operation current to achieve a higher efficiency power conversion. Start-up current has been reduced to 30uA typical and operating current has been shrunk to 3mA. The SG6840 is a fixed frequency PWM controller in normal operation; its patented green-mode function will decrease the PWM frequency in response to the decrease of the load. This green function dramatically reduces the power loss in no load and light load conditions that assist the power supply to meet the power conservation requirement. The proprietary synchronized slope compensation ensures the stability of the current loop for continuous-mode operation. Built-in line-voltage compensation maintains an identical output power for a wide input range. An NTC thermistor is applied to sense the temperature for over-temperature protection. The SG6840 is available in 8-pin DIP and SO packages.

APPLICATIONS

General-purpose switching mode power supplies and flyback power converters, and

- Power Adapter
- Open-frame SMPS
- Battery Charger Adapter

FEATURES OVERVIEW

- Green-mode PWM to support “Blue Angle” Norm
- Low start up current 30uA
- Low operation current 3mA
- Leading-edge blanking
- Built-in synchronized slope compensation
- Totem pole output includes soft driving
- Constant output power
- Current mode operation
- Cycle-by-cycle current limiting
- Under voltage lockout (UVLO)
- Short circuit protection
- Programmable over-temperature protection
- Few external components & low cost solution

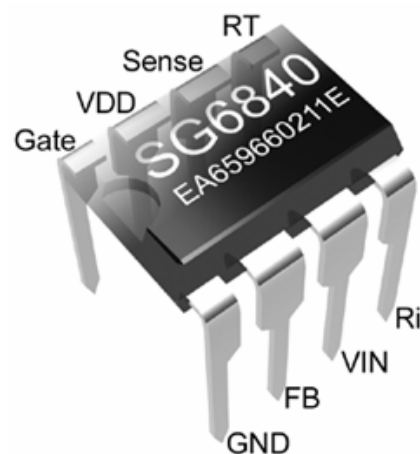
PIN CONFIGURATION

SG6840

PIN DESCRIPTIONS

Name	Pin No.	Type	Function
VDD	7	Supply	Power supply.
VIN	3	Analog input	The start-up current input. A start-up resistor is connected from the line-input to this pin, such as 1.5MΩ for off-line converter. Adjust the start-up resistor to vary the line voltage compensation for constant
FB	2	Analog input	Feedback. The FB pin provides the information of the regulation, it effects to the internal PWM comparator to control the duty cycle.
Sense	6	Analog input	Current sense. It senses the voltage developed on a sensed resistor. When it reaches the internal threshold, the PWM output is disabled. Therefore, the over-current protection is realized. Besides, the current information is providing for the current mode control.
RT	5	Analog input/output	For over-temperature protection. A constant current is output. An NTC thermistor is connected from this pin to ground to sense the temperature. When the voltage in this pin is lower than the limit, which will enable the over-temperature protection.
Gate	8	Driver out-	The totem-pole output driver to drive the power MOSFET.
Ri	4	Program-	Reference setting. Connect a resistor to ground to generate a con-
GND	1	Supply	Ground.

BLOCK DIAGRAM

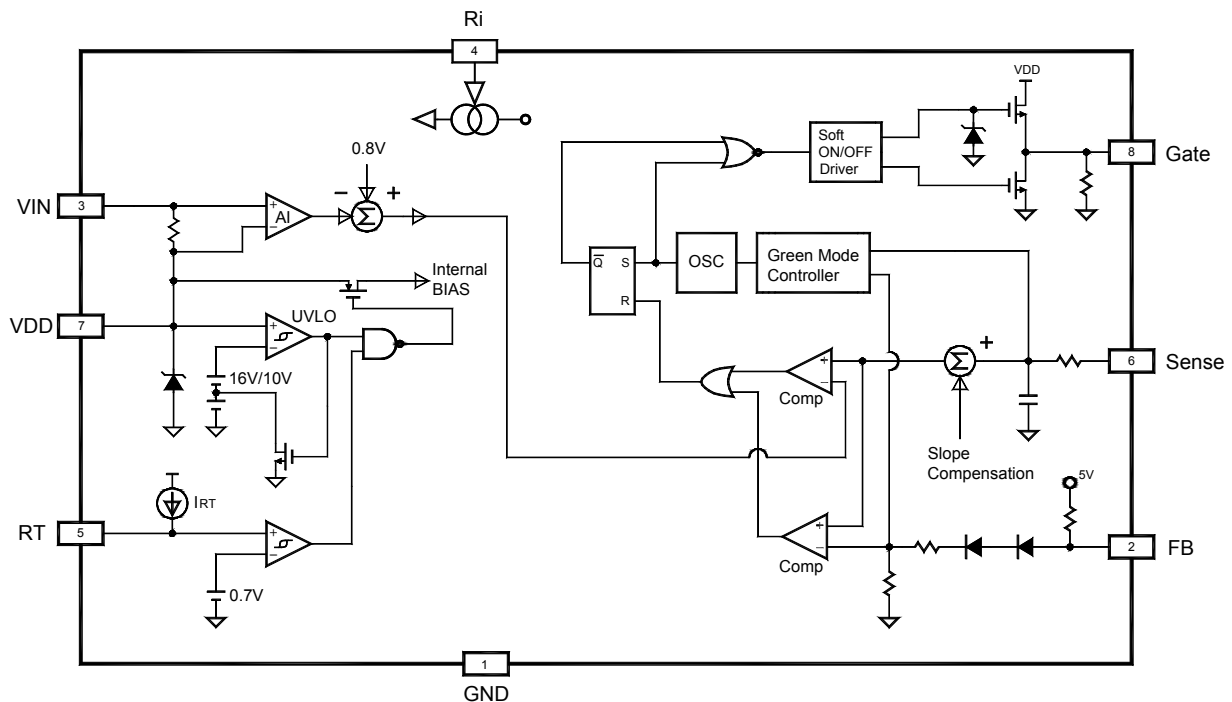

ABSOLUTE MAXIMUM RATINGS

Symbol	Parameter	Value	Unit
VDD	DC Supply Voltage – note 1	20	V
I _{out}	Gate Output Current	500	mA
V _{FB}	Input Voltage to FB Pin	-0.3 to 7 V	V
V _{Sense}	Input Voltage to Sense Pin	-0.3 to 7V	V
P _d	Power Dissipation	1	W
T _J	Operating Junction Temperature	150	°C
T _A	Operating Ambient Temperature	-25 to 85	°C
T _{stg}	Storage Temperature Range	-55 to +150	°C

Note: All voltage values, except differential voltage, are with respect to network ground terminal.

ELECTRICAL CHARACTERISTICS(VDD=15V, TA=25)
Feedback Input Section

Symbol	Parameter	Test Condition	Min.	Typ.	Max.	Unit
A _v	Input-voltage to current-sense attenuation		1/4.5	1/5	1/5.5	V/V
Z _{fb}	Input impedance		3	4.5	6	KΩ
I _{fb}	Bias current				2	mA
V _{oz}	Input voltage for zero duty cycle				1.2	V

Current Sense Section

Symbol	Parameter	Test Condition	Min.	Typ.	Max.	Unit
Z _{cs}	Input impedance		8	12	16	KΩ
T _{PD}	Delay to Output			150	200	nS
V _{th}	Threshold voltage for current limit		0.8	0.85	0.9	V
ΔV _{th @ I_{in}}	The change of threshold voltage versus the input current of the V _{in}	I _{in} = 220 uA	-0.09	-0.15	-0.21	V

Oscillator Section

Symbol	Parameter	Test Condition	Min.	Typ.	Max.	Unit
F _{osc}	Frequency	R _i =26KOhms	60	65	70	KHz
F _{osc-green}	Frequency in green mode	R _i =26KOhms		10	15	KHz
V _g	Green mode voltage (V _g = V _{fb} - V _d)			1.3		V
V _n	Normal mode voltage (V _n = V _{fb} - V _d) V _n = 4 V for maximum duty cycle		1.7	2	2.3	V
S _g	Slope for green mode modulation	R _i =26KOhms	50	80	120	Hz/ mV
F _{dv}	Frequency variation versus VDD deviation	VDD=10 to 20V			5	%
F _{dt}	Frequency variation versus Temp. deviation	TA=-25 to 85 °C			5	%

SG6840
PWM Section

Symbol	Parameter	Test Condition	Min.	Typ.	Max.	Unit
DC _(MAX)	Maximum Duty Cycle		75	80	90	%
DC _(MIN)	Minimum Duty Cycle		-	-	0	%
Bnk	Leading edge blanking time		200	270	350	nsec

Output Section

Symbol	Parameter	Test Condition	Min.	Typ.	Max.	Unit
V _{ol}	Output Voltage Low	VDD= 12V, I _o = 150mA			1.5	V
V _{oh}	Output Voltage High	VDD= 12V, I _o = 50mA	8V			V
t _r	Rising Time	VDD=13V, CL=1nF	150	250	350	NS
t _f	Falling Time	VDD=13V, CL=1nF	30	50	90	NS

Under-voltage Lockout Section

Symbol	Parameter	Test Condition	Min.	Typ.	Max.	Unit
V _{TH(ON)}	Start Threshold Voltage		15	16	17	V
V _{DD(min)}	Min. Operating Voltage		9	10	11	V

Over-temperature Protection Section

Symbol	Parameter	Test Condition	Min.	Typ.	Max.	Unit
I _{rt}	Output current of pin RT	R _i =26KOhms	92	100	108	uA
V _{tov}	Threshold voltage for over-temperature protection		0.665	0.7	0.735	V

Total Standby Current Section

Symbol	Parameter	Test Condition	Min.	Typ.	Max.	Unit
I _{DD ST}	Start-up Current			30	40	uA
I _{DD OP}	Operating Supply Current	-	-	3	5	mA

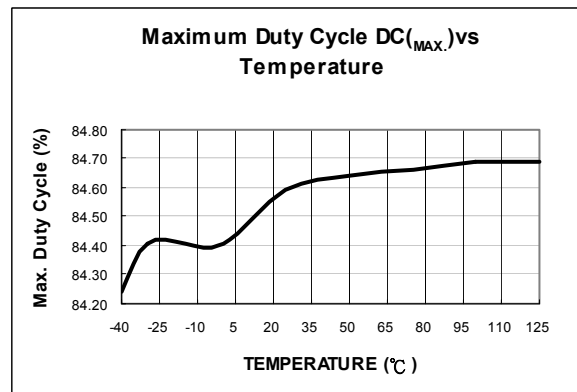
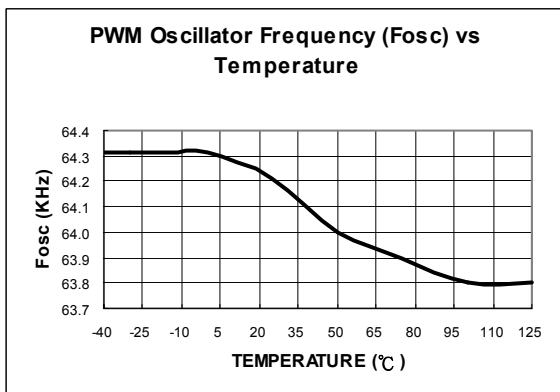
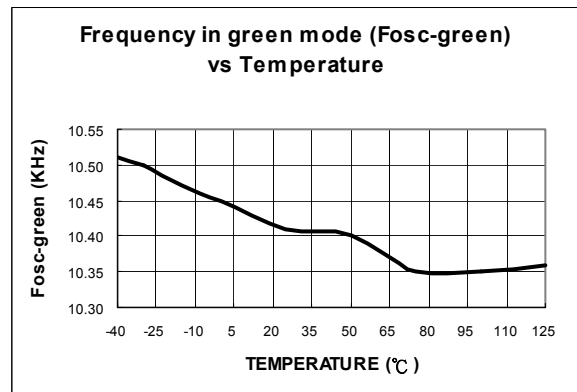
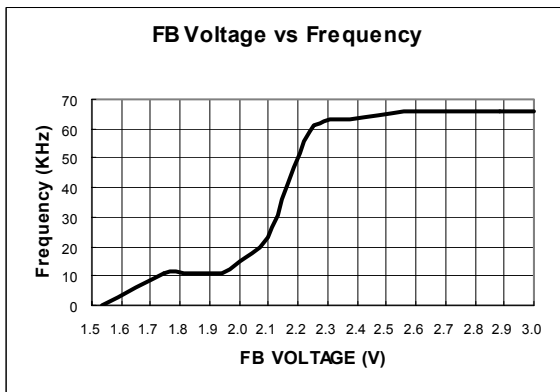
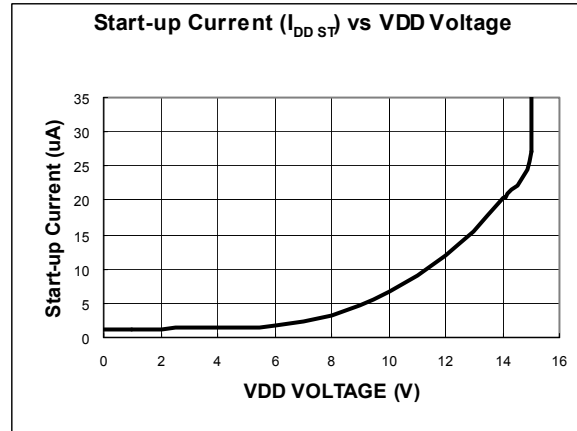
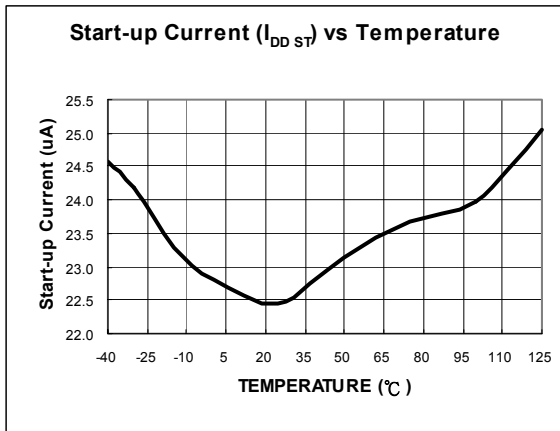

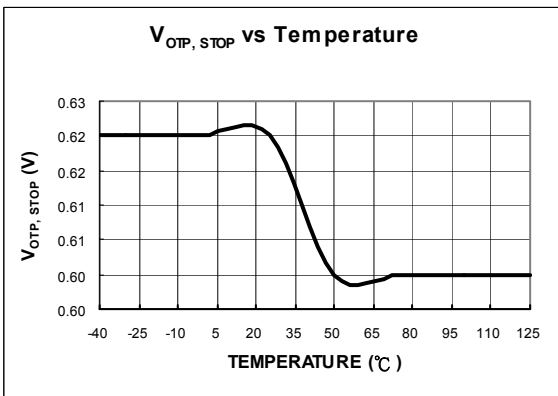
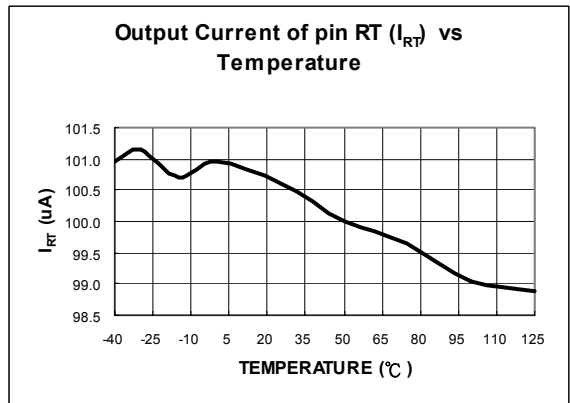
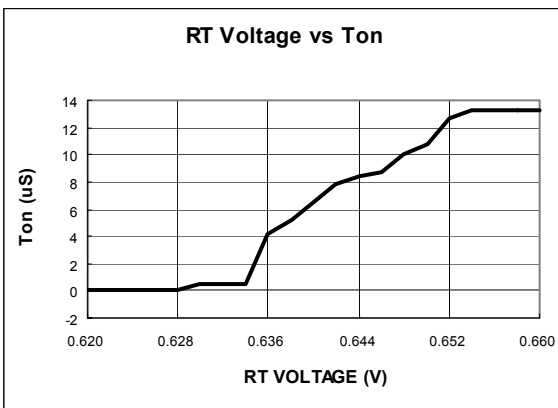
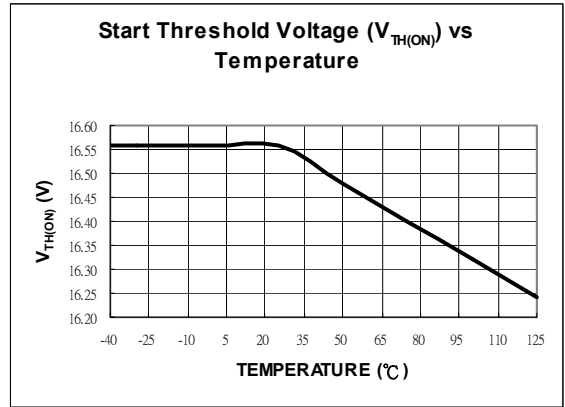
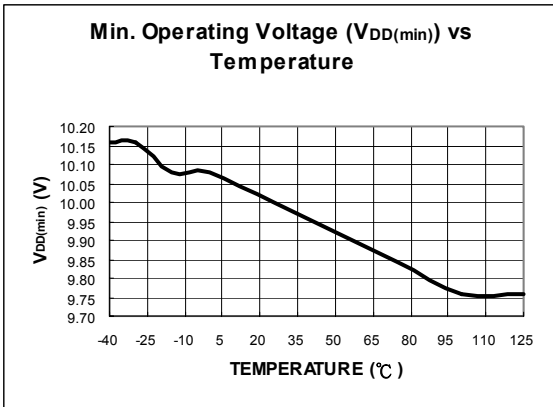

OPERATION DESCRIPTION

Start-up Current

Typical start-up current is only 30uA. This ultra low start-up current allows users to use a high resistance, and low-wattage, start-up resistor to supply the start-up power required by SG6840. Take a wide input-range (100V_{AC}~240V_{AC}) of AC-to-DC power adapter as an example, an 1.5 MΩ, 0.25W, start-up resistor and a 10uF/25V VDD hold-up

Operating Current

Operating current has been reduced to 3mA. The low operating current enables a better efficiency and reduces the

Green Mode Operation

The patented green-mode function provides an off-time modulation to reduce the switching frequency in the light load and no load conditions. The feedback voltage, which is derived from the voltage feedback loop, is taken as the reference. Once the feedback voltage is lower than the threshold voltage, switching frequency will linearly decrease until the minimum green mode frequency around 10kHz (R_i =26kΩ). We can find that all of the losses are in proportional to the switching frequency, such as the switching loss of the transistor, the core loss of the transformer and inductors, and the power loss of the snubber, etc. The off-time modulation in the PWM controller can reduce the power consumption of the power supply in light load and no load conditions. In normal load and high load conditions, the PWM frequency is at its maximum frequency around 65kHz (R_i =26kΩ) and not affected by the off-time modulation.

Oscillator Operation

An external resistor R_i determines the PWM oscillation frequency. A 26kΩ resistor R_i creates a 50uA constant current I_i and generates 65kHz switching frequency.

$$I_i \text{ (mA)} = 1.3V / R_i \text{ (k}\Omega\text{)};$$

$$f_{\text{PWM}} = \frac{1690}{R_i \text{ (k}\Omega\text{)}} \text{ (kHz)} \quad (1)$$

Current sensing and PWM current limiting

SG6840 consists of two feedback loops: voltage loop and current loop, to control the load regulation. SG6840's current sense input is designed for the current-mode control. A current-to-voltage conversion is done externally through a current-sense resistor R_s. Under normal operation, the FB voltage V_{FB} controls the peak voltage across the sense resistor R_s, hence the PWM duty cycle, as follows:

$$I_{pk} = (V_{FB} - 1.4) / 5R_s;$$

where V_{FB} is the voltage on pin FB

When the DC output voltage of secondary side decreases due to heavy load conditions, the FB voltage V_{FB} will increase such that the PWM duty cycle increases to regulate the output voltage of secondary side back to its normal voltage. The inverting input to SG6840's current-sense comparator is internally clamped to a variable voltage around 0.85V (note: see Constant Output Power Limit section). The current limiting occurs if the voltage of SENSE pin reaches this 0.85V threshold value, such as I_{pk} (max) = 0.85V/R_s. The value of sense resistor R_s decides the maximum power limit. Larger R_s, whose I_{pk} is smaller, results in a smaller power limit

Leading Edge Blanking

Each time when the power MOSFET is switched on, a leading spike is generated due to parasitic capacitance. To avoid premature termination of the switching pulse, this leading edge spike is blanked out with a time constant 270 nsec. During this time period, the current-limit comparator is disabled and cannot switch off the gate drive regardless how big the SENSE voltage is.

Under-voltage lockout (UVLO)

The UVLO Under-Voltage Lockout (UVLO) function ensures the supply voltage V_{DD} for SG6840 is adequate to fully function before enabling the output stage. The turn-on and turn-off threshold voltages are fixed internally at 16V/10V. The hysteresis voltage between turn-on and turn-off prevents V_{DD} from being unstable during power on/off sequencing. Start-up current is typically 30uA for efficient bootstrapping from the rectified input for an off-line converter. During the normal operation, V_{DD} is developed from an auxiliary winding of the transformer. At the moment of start-up, V_{DD} hold-up capacitor C_{IN} must be charged up to 16V through the start-up resistor R_{IN} before enabling the output switch. With an ultra small start-up current of 30uA, R_{IN} can be as large as 1.5 MΩ and still be able to charge up the hold-up capacitor C_{IN} even when V_{AC} = 90Vrms. Power dissipation of this large resistance R_{IN} would then be less than 70mW (0.07W) even under high line (V_{AC} =

SG6840

Gate Output / Soft Driving

The SG6840 BiCMOS output stage is a fast totem pole gate driver, which is designed to avoid cross conduction current. This minimizes heat dissipation, increases efficiency and enhances reliability. The output driver is clamped by an internal 18V Zener diode in order to improve the control of the power MOSFET transistors and protect them against undesirable gate over-voltage. By controlling the rising time of the switch-on waveform and falling shape of the switch-off waveform, the output stage is optimized to reduce switching noise, improve EMI, and to provide a stable MOSFET gate drive.

Built-in Slope Compensation

Current mode control regulates the peak transformer/inductor current via the current control loop. In a continuous mode operation, the current is the average current, and composed of both AC and DC components. Since the output is proportional to the average, not the peak current, this causes oscillation when input voltage is changed. Adding the slope compensation to the current loop (reduce the current loop gain) to correct the problem is a simple approach. The SG6840 inserts a synchronized 0.33V positive-going ramp at every switching cycle to stabilize the current loop. $V_{s-comp} = 0.33V$.

Constant Output Power Limit

Every time when the SENSE voltage, across the sense resistor R_s , is larger than the threshold voltage around 0.85V, the output GATE drive is turned off after a small propagation delay t_D . Since the propagation delay is constant regardless the input line voltage V_{IN} , the output power would not be equal for the wide input voltage V_{IN} of 90Vrms to 265Vrms. To compensate the different output power limit between high line voltage and low line voltage, the internal threshold voltage is adjusted dependent on the input line voltage V_{IN} through the VIN pin. The threshold voltage is decreased from 0.85V to a smaller voltage when input line voltage V_{IN} increases. Smaller threshold voltage, at higher input line voltage, forces the output GATE drive to terminate earlier, thus reduce the total PWM turn-on time and make the output power equal to that of low input line voltage.

Thermal Protection

A constant current I_{RT} is output from pin RT. The resistor in pin Ri decides the current I_{RT} .

$$I_{RT} = 2 \times (1.3V / Ri);$$

An NTC thermistor R_{ntc} in series with a resistor R_a can be connected from pin RT to ground. The over-temperature

Noise immunity

Noise on the current sense or control signal can cause significant pulse width jitter, particularly with the continuous-mode operation. While slope compensation helps alleviate this problem. Note that the SG6840 has a single ground pin. High sink current in the output therefore cannot be returned separately. Good high frequency or RF layout practices should be followed. Avoid long PCB traces and component leads. Locate components such as R_i , R_t and VDD capacitor near to the SG6840. The noise, which often causes the problem, is caused by the output (pin 8) being pulled below ground at turn-off by external parasitic. This is particularly true when driving MOSFET. A resistor (10 ~ 20 ohms) series connected from the output (pin 8) to the gate of MOSFET will prevent such output noise.

SG6840

APPLICATION CIRCUIT

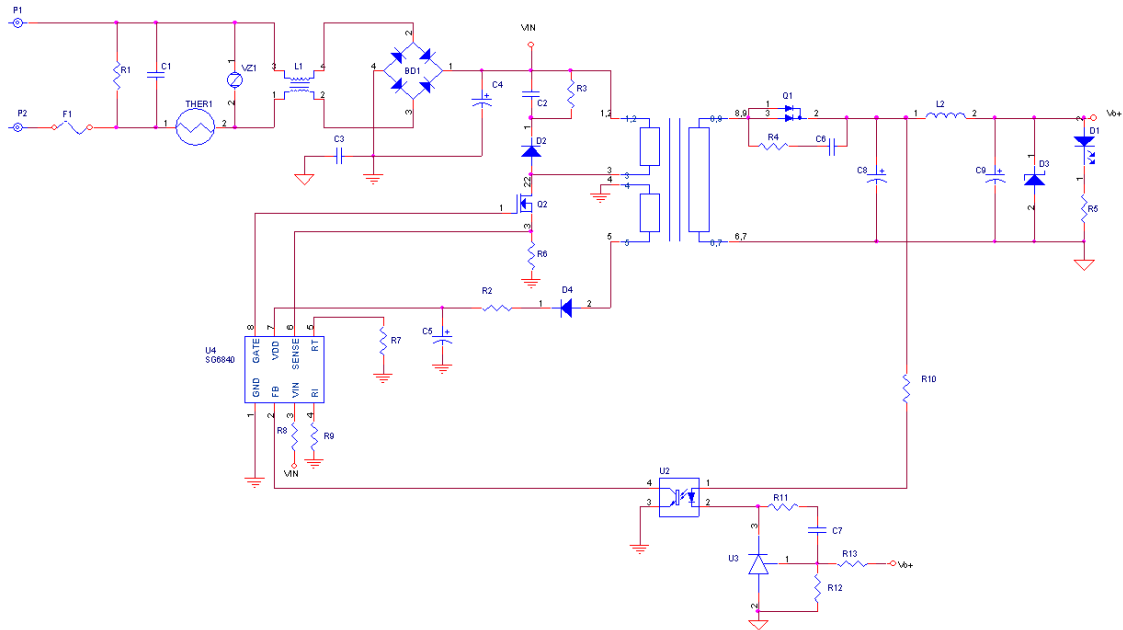

BOM

Reference	Component	Reference	Component
BD1	BD 1A/600V	Q2	MOS 2A/600V
C1	XC 0.22u	R1,R2	R 470Kohm 1/4W
C2	EC 0.1u 250V	R3	R 47ohm 1/4W
C3,C6,C7	YC 222p	R4	R 22ohm 1/4W
C4	EC 68u/400V	R5	R 4.7Kohm 1/4W
C5	CC 102p/1KV	R6	R 0.5ohm 1W
C8	EC 1200u/16V	R8,R12	R 510Kohm 1/4W
C9	EC 680u/16V	R9	R 20Kohm 1/8W 1%
C10	EC 10u/25V	R10	R 100ohm 1/8W
D1	LED	THER1	Thermistor SCK054
D3	ZD 12V	T1	Transformer EI28
F1	FUSE 2A/250V	U1	IC SG6840
L1	UU10.5	U2	IC 4N35D
L2	L04	U3	IC TL431
Q1	DIODE	VZ1	VZ 9G

SG6840

MECHANICAL DIMENSIONS

8 PINS – PLASTIC DIP (D)

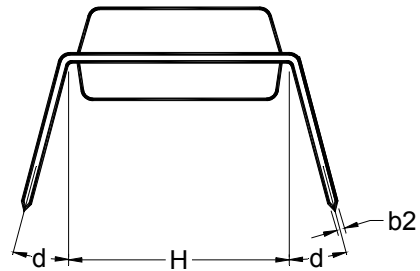
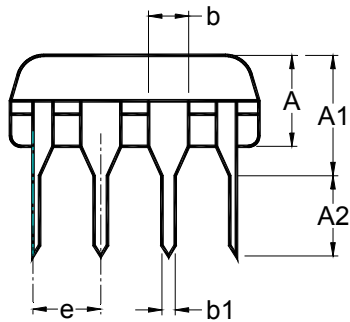
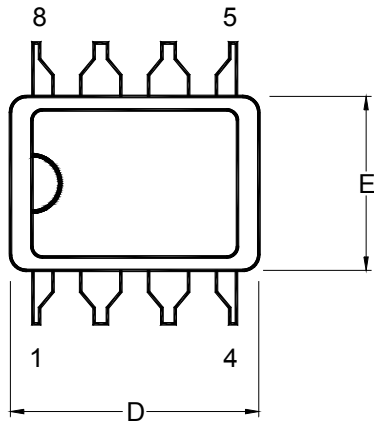

Symbol	Millimeter			Inch		
	Min.	Typ.	Max.	Min.	Typ.	Max.
A		3.4			0.134	
A1			4.5			0.177
A2	3.0			0.118		
b		1.5			0.059	
b1	0.4	0.5	0.6	0.016	0.020	0.024
b2	0.25	0.3	0.4	0.010	0.012	0.016
d	0°		15°	0°		15°
D		9.3			0.366	
E		6.5			0.256	
e	2.29	2.54	2.79	0.090	0.100	0.110
H		7.6			0.299	

SG6840

MECHANICAL DIMENSIONS

8 PINS – PLASTIC SMD (S)

Dimension:

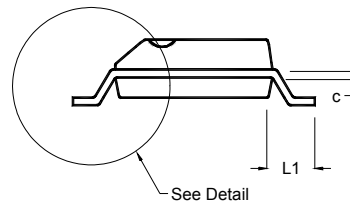
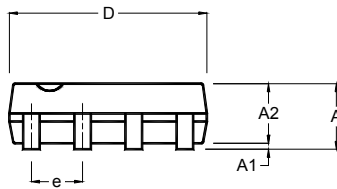
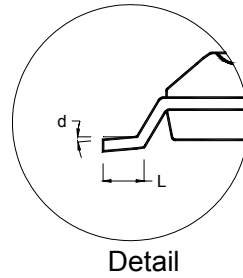
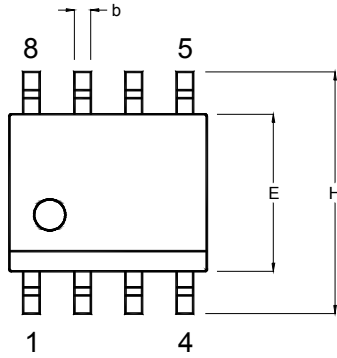

Symbol	Millimeter			Inch		
	Min.	Typ.	Max.	Min.	Typ.	Max.
A	1.35	1.63	1.75	0.053	0.064	0.069
A1	0.10	0.15	0.25	0.004	0.006	0.010
A2	1.30	1.40	1.50	0.051	0.055	0.059
b	0.33	0.41	0.51	0.013	0.016	0.020
c	0.19	-	0.25	0.007	-	0.010
d	0°	-	8°	0°	-	8°
D	4.80	4.90	5.00	0.189	0.193	0.197
E	3.80	3.90	4.00	0.150	0.154	0.157
e	-	1.27	-	-	0.050	-
H	5.80	6.00	6.20	0.228	0.236	0.244
L	0.40	0.64	1.27	0.016	0.025	0.050
L1	-	1.07	-	-	0.042	-
Y	-	-	0.10	-	-	0.004