

**LA4743B****45 W Four-Channel (Bridge Circuit) Power Amplifier****Overview**

The LA4743B is a 45 W 4-channel power amplifier IC for car stereo systems. It features a built-in bridge circuit and the ability to radically reduce the number of external components required. It is also pin compatible with the LA4743A, which differs in the amount of gain provided.

Features

- Maximum output power: 45 W × 4 channels ($V_{CC} = 14.4$ V, 4 Ω load, 1 kHz)
- 40 W × 4 channels ($V_{CC} = 13.7$ V, 4 Ω load, 1 kHz)
- Requires only seven external components and does not require an oscillation prevention RC circuit, a noise filter, or a BS capacitor.

Functions

- Muting function
- Built-in standby switch
- Full complement of built-in protection circuits, including protection from shorting to V_{CC} , shorting to ground, load shorting, overvoltages, and overheating.

Package Dimensions

unit: mm

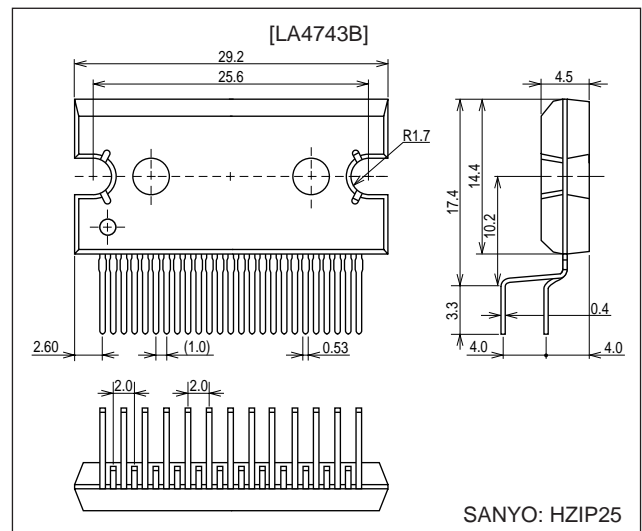
3236-HZIP25**Specifications****Maximum Ratings at $T_a = 25^\circ\text{C}$**

| Parameter | Symbol | Conditions | Ratings | Unit |
|-----------------------------|---------------|-------------------------------------|-------------|--------------------|
| Maximum supply voltage | V_{CC} max1 | Signal present | 18 | V |
| | V_{CC} max2 | No signal (for 1 minute) | 26 | V |
| Maximum output current | I_{Opeak} | | 4.5/ch | A |
| Allowable power dissipation | P_d max | With an arbitrarily large heat sink | 50 | W |
| Operating temperature | T_{opr} | | -40 to +85 | $^\circ\text{C}$ |
| Storage temperature | T_{stg} | | -40 to +150 | $^\circ\text{C}$ |
| Package thermal resistance | θ_{jc} | | 1 | $^\circ\text{C/W}$ |

■ Any and all SANYO products described or contained herein do not have specifications that can handle applications that require extremely high levels of reliability, such as life-support systems, aircraft's control systems, or other applications whose failure can be reasonably expected to result in serious physical and/or material damage. Consult with your SANYO representative nearest you before using any SANYO products described or contained herein in such applications.

■ SANYO assumes no responsibility for equipment failures that result from using products at values that exceed, even momentarily, rated values (such as maximum ratings, operating condition ranges, or other parameters) listed in products specifications of any and all SANYO products described or contained herein.

SANYO Electric Co.,Ltd. Semiconductor Company

TOKYO OFFICE Tokyo Bldg., 1-10, 1 Chome, Ueno, Taito-ku, TOKYO, 110-8534 JAPAN

LA4743B

Operating Conditions at $T_a = 25^\circ\text{C}$

| Parameter | Symbol | Conditions | Ratings | Unit |
|--------------------------------|--------------|------------|---------|----------|
| Recommended supply voltage | V_{CC} | | 14.4 | V |
| Recommended load resistance | R_L | | 4 | Ω |
| Operating supply voltage range | $V_{CC\ op}$ | | 9 to 18 | V |

Operating Characteristics at $T_a = 25^\circ\text{C}$, $V_{CC} = 14.4\text{ V}$, $f = 1\text{ kHz}$, $R_L = 4\ \Omega$, $R_g = 600\ \Omega$

| Parameter | Symbol | Conditions | Ratings | | | Unit |
|---------------------------|-------------------|--|---------|-----|------|------------------|
| | | | min | typ | max | |
| Quiescent current | I_{CCO} | $R_L = \infty$, $R_g = 0$ | 100 | 200 | 350 | mA |
| Standby current | I_{st} | $V_{st} = 0\text{ V}$ | | | 10 | μA |
| Output offset voltage | $V_{Noffset}$ | $R_g = 0$ | -150 | | +150 | mV |
| Voltage gain | VG | $V_O = 0\text{ dBm}$ | 31 | 32 | 33 | dB |
| Voltage gain difference | ΔVG | | -1 | | +1 | dB |
| Output power | P_{O1} | THD = 10 % | 23 | 28 | | W |
| | $P_{O\ max1}$ | $V_{CC} = 13.7\text{ V}$, $V_{IN} = 5\text{ Vrms}$ | | 40 | | W |
| | $P_{O\ max2}$ | $V_{IN} = 5\text{ Vrms}$ | | 45 | | W |
| Total harmonic distortion | THD | $P_O = 4\text{ W}$ | | 0.1 | 0.4 | % |
| Channel separation | CHsep | $V_O = 0\text{ dBm}$, $R_g = 10\text{ k}\Omega$ | 50 | 60 | | dB |
| Ripple rejection ratio | SVRR | $f_r = 100\text{ Hz}$, $V_R = 0\text{ dBm}$, $R_g = 0$ | 43 | 50 | | dB |
| Output noise voltage | V_{NO} | $R_g = 0$, B.P.F. = 20 Hz to 20 kHz | | 250 | 450 | μVrms |
| Muting attenuation | Mute(att) | $V_O = 20\text{ dBm}$ | 70 | 80 | | dB |

LA4743B

Sample Application Circuit and Block Diagram

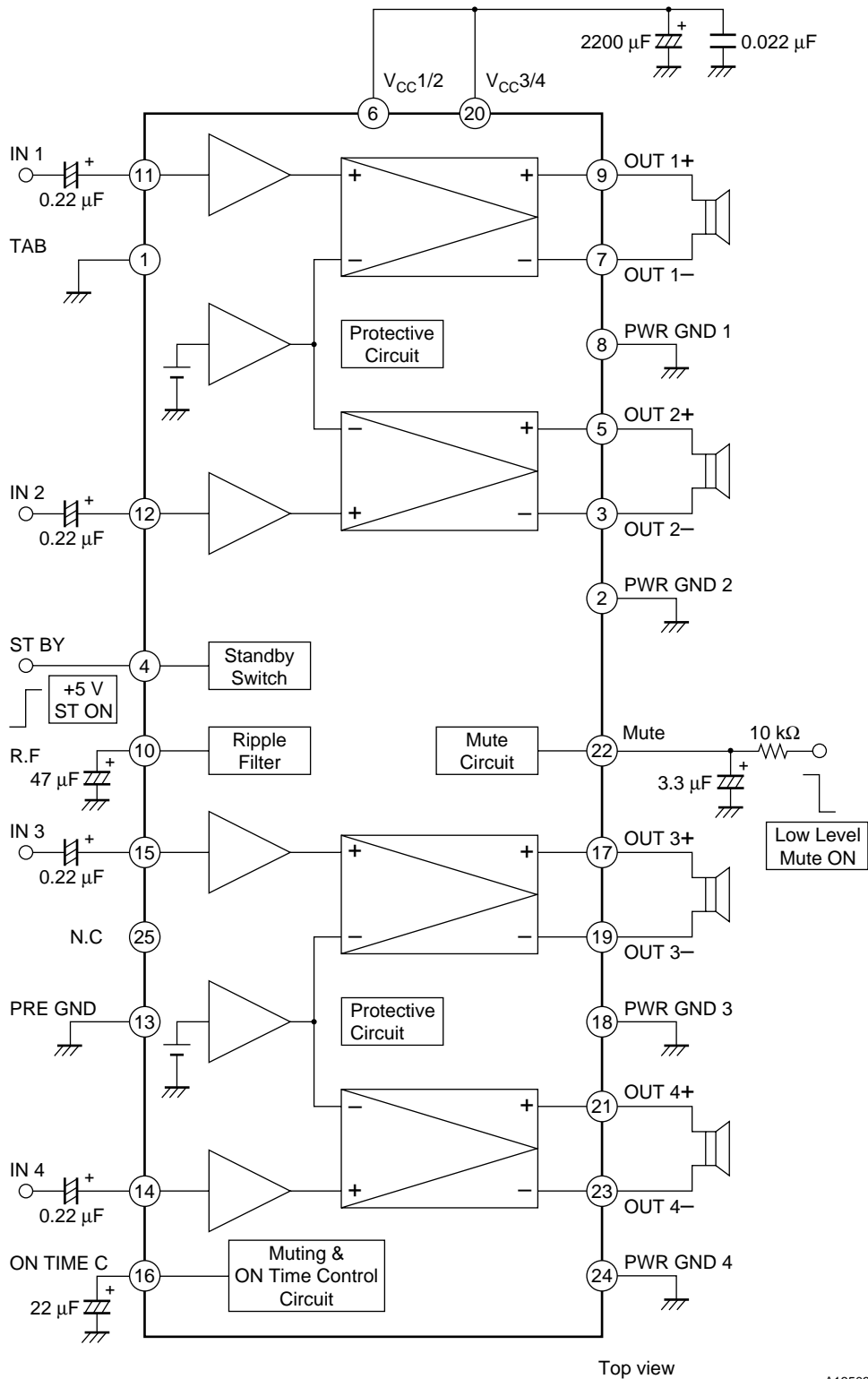

A13503

LA4743B

Pin Functions and Equivalent Circuits at $V_{CC} = 14.4\text{ V}$, $ST-BY = 5\text{ V}$

| Pin No. | Function | DC voltage [V] | Notes | Internal equivalent circuit |
|--|--|----------------|---|--|
| 1 | TAB | | | |
| 2 8 18 24 | POWER GND | | | |
| 3 5 7 9 17 19 21 23 | -OUT2 +OUT2 -OUT1 +OUT1 +OUT3 -OUT3 +OUT4 -OUT4 | 2.7 | | <p style="text-align: right;">A13504</p> |
| 4 | ST-BY | | <ul style="list-style-type: none"> The amplifier will be on when the applied voltage is between 2 V and V_{CC}. | <p style="text-align: right;">A13505</p> |
| 6 20 | $V_{CC}1/2$ $V_{CC}3/4$ | | | |
| 10 | SVR | 13.2 | <ul style="list-style-type: none"> Low ripple power supply line for all internal IC blocks | <p style="text-align: right;">A13506</p> |

Continued on next page.

LA4743B

Continued from preceding page.

| Pin No. | Function | DC voltage [V] | Notes | Internal equivalent circuit |
|----------------------|--------------------------|----------------|---|--|
| 11 12 14 15 | IN1 IN2 IN4 IN3 | 3.1 | <ul style="list-style-type: none"> Input amplifiers that require no capacitor in the input noise filter. | <p style="text-align: right;">A13507</p> |
| 16 | ON TIME MUTE | 2.6 | <ul style="list-style-type: none"> Amplifier turn-on time control circuit Impulse noise prevention circuit With a 22 μF capacitor, the turn-on time will be 0.6 s. | <p style="text-align: right;">A13508</p> |
| 22 | MUTE | 4.1 | <ul style="list-style-type: none"> The muting function is activated when the applied voltage is under 1 V. | <p style="text-align: right;">A13509</p> |
| 25 | N.C. | | | |

Notes on Usage and Handling

• Oscillator stabilization time

In some cases, details of the printed circuit board layout may lead to induced parasitic oscillation. This oscillation can be prevented by adding any one of the following components. Verify the optimal values for these capacitors by testing in actual end products.

Technique 1 ... Connect Mylar capacitors (0.1 μF) between the BTL amplifier outputs.

Technique 2 ... Connect an RC circuit (2.2 Ω and 0.1 μF in series) between each output and ground.

• Audio quality (low band)

The low-band frequency characteristics can be improved by adjusting the values of the input capacitors. The recommended value is 2.2 μF .

• Impulse noise

The LA4743B includes a built-in impulse noise suppression circuit. However, further improvement can be achieved by using the muting circuit. When first applying power, activate the muting function at the same time as applying power. Then, after the output DC potential has stabilized, turn off the muting function. When turning off the power, first activate the muting function and then turn off the power. Sample transient responses are attached (see the timing charts).

Transient Responses at Power On

Power on: Standby and muting activated at the same time.

Muting is turned off after the output has stabilized.

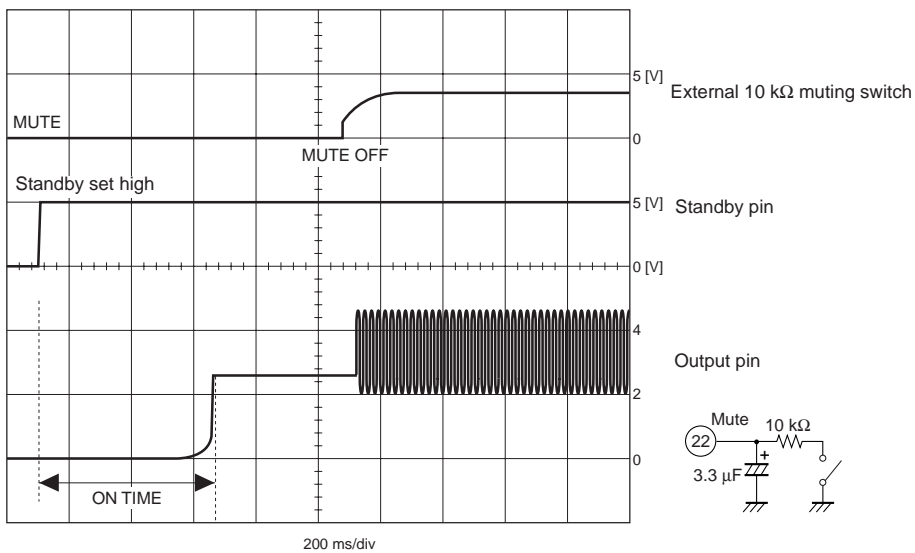

Transient Responses at Power Off

Power off: After activating the muting circuit, turn the power off.

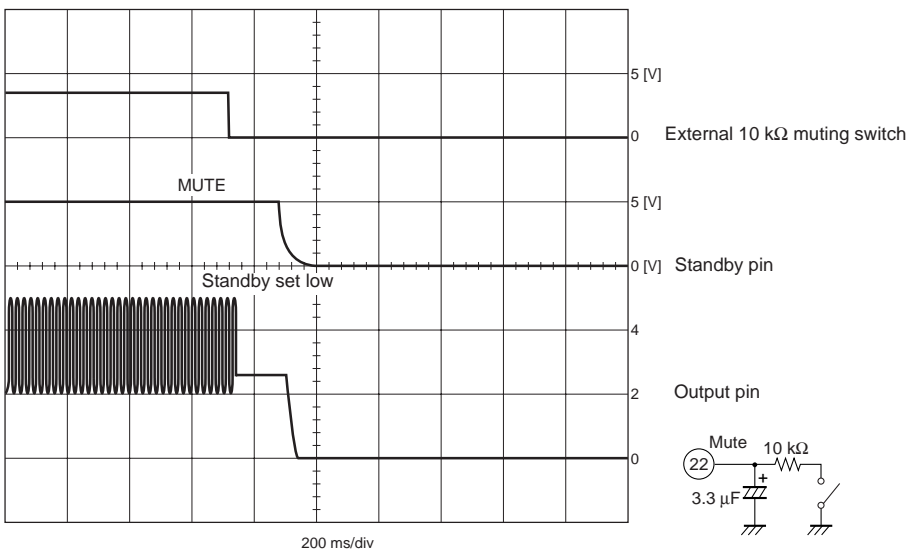

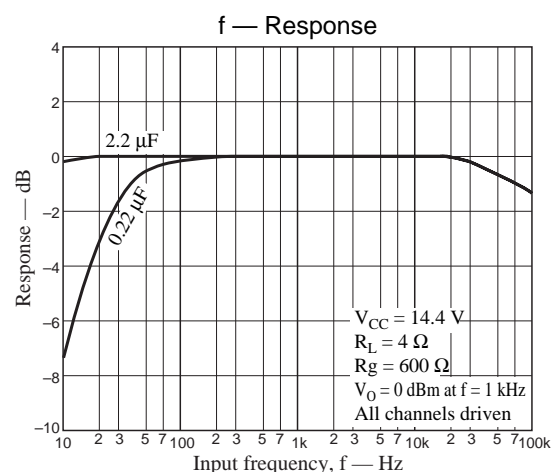
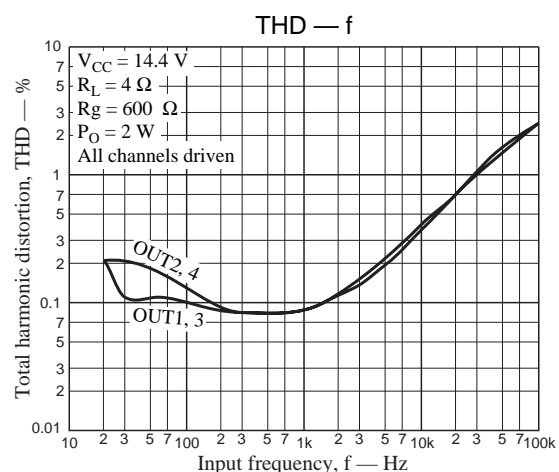
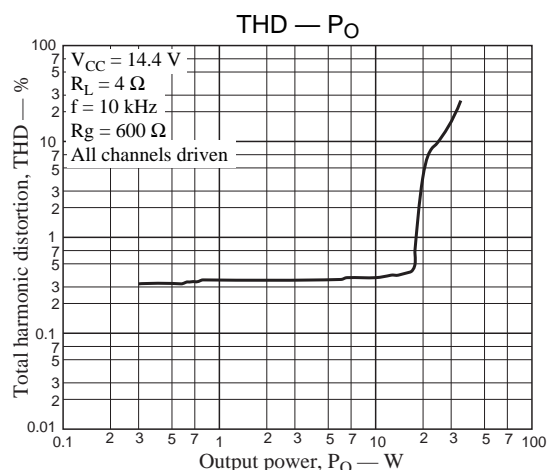
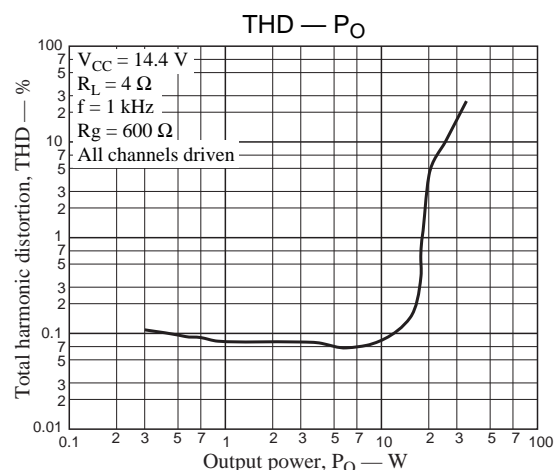
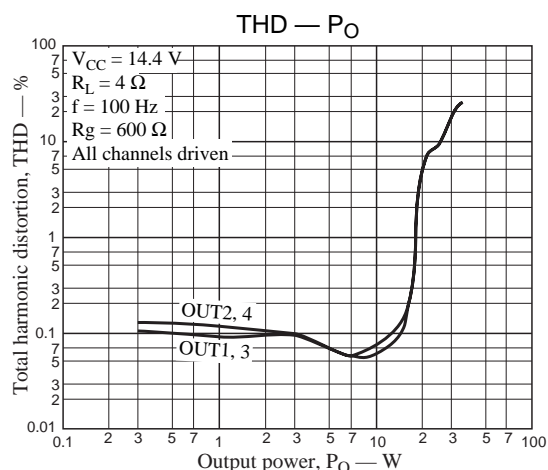
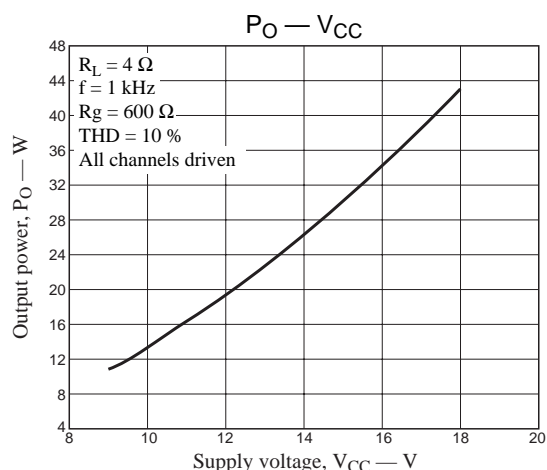
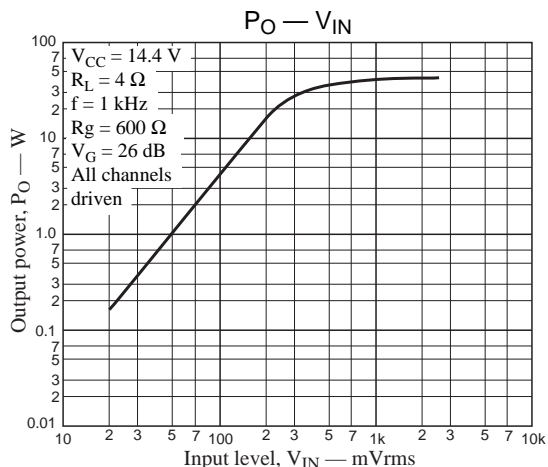
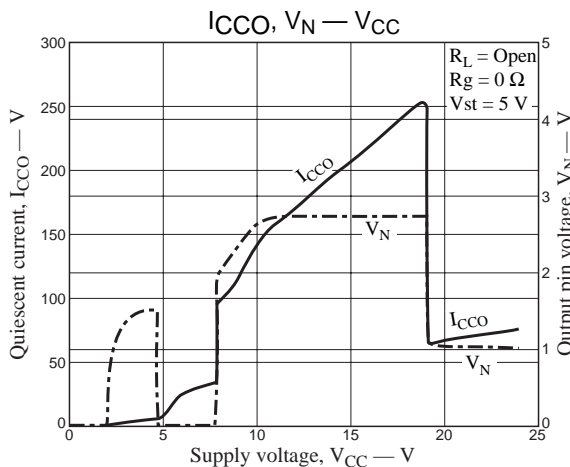

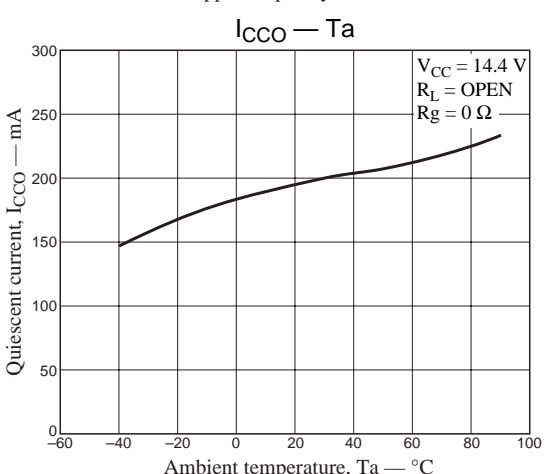
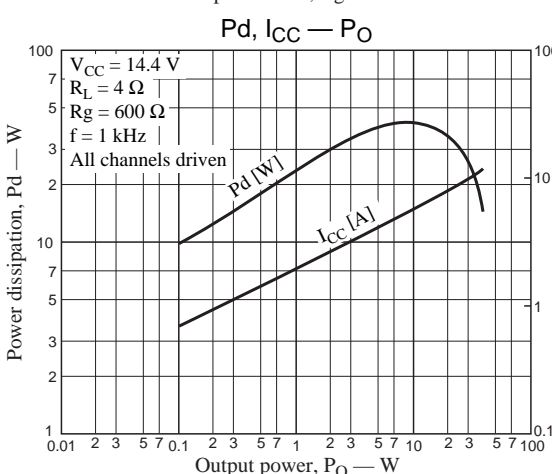
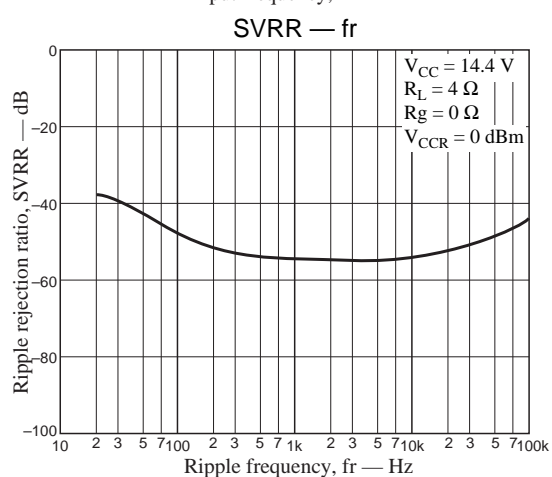
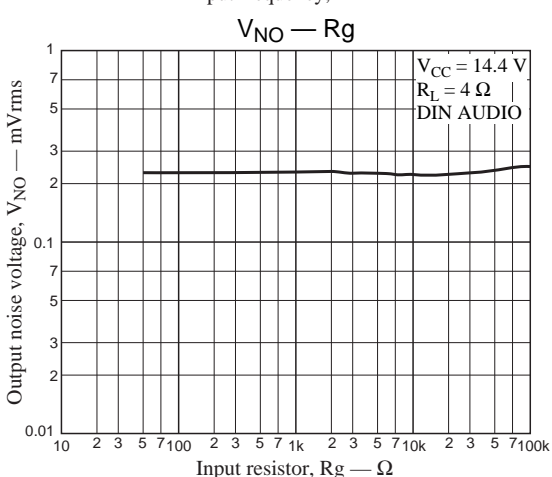
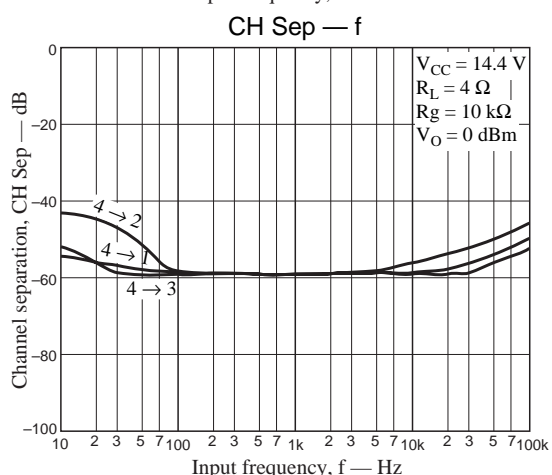
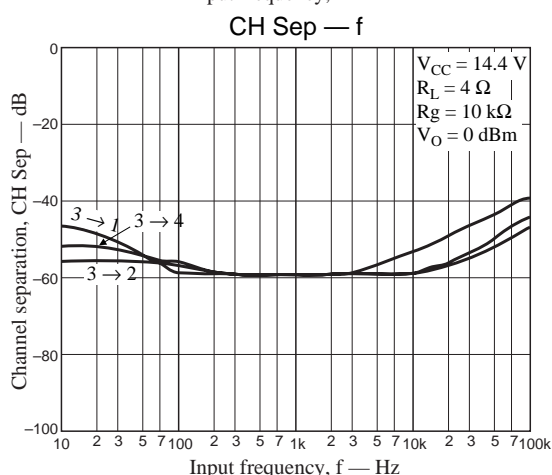
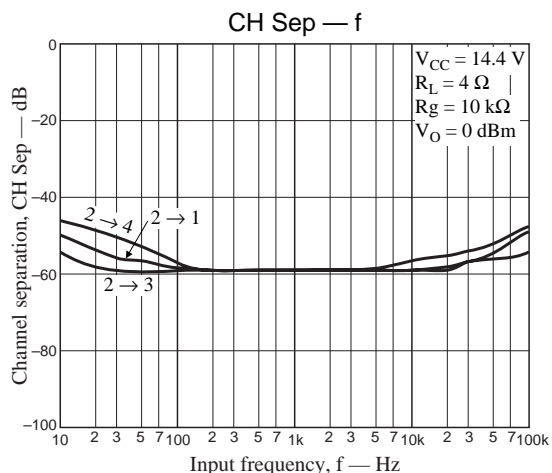
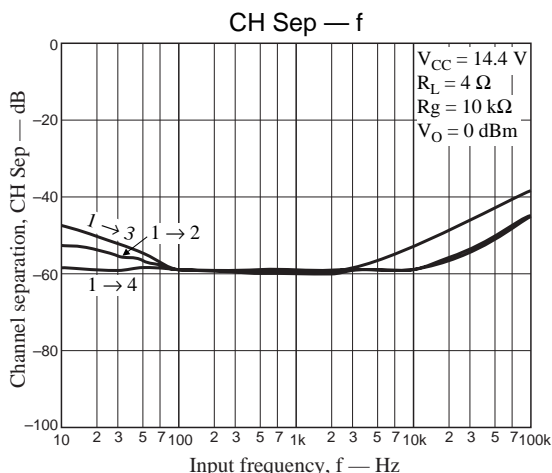

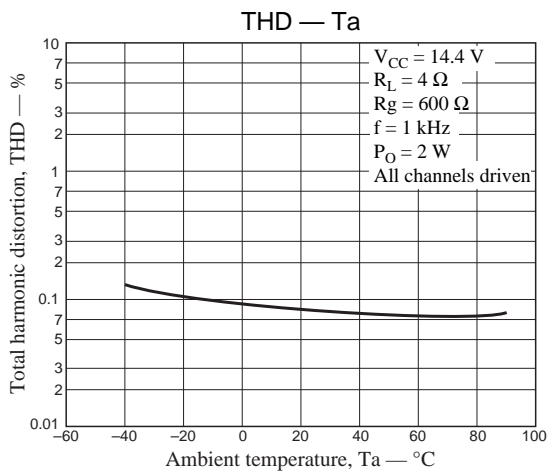

- Specifications of any and all SANYO products described or contained herein stipulate the performance, characteristics, and functions of the described products in the independent state, and are not guarantees of the performance, characteristics, and functions of the described products as mounted in the customer's products or equipment. To verify symptoms and states that cannot be evaluated in an independent device, the customer should always evaluate and test devices mounted in the customer's products or equipment.
- SANYO Electric Co., Ltd. strives to supply high-quality high-reliability products. However, any and all semiconductor products fail with some probability. It is possible that these probabilistic failures could give rise to accidents or events that could endanger human lives, that could give rise to smoke or fire, or that could cause damage to other property. When designing equipment, adopt safety measures so that these kinds of accidents or events cannot occur. Such measures include but are not limited to protective circuits and error prevention circuits for safe design, redundant design, and structural design.
- In the event that any or all SANYO products (including technical data, services) described or contained herein are controlled under any of applicable local export control laws and regulations, such products must not be exported without obtaining the export license from the authorities concerned in accordance with the above law.
- No part of this publication may be reproduced or transmitted in any form or by any means, electronic or mechanical, including photocopying and recording, or any information storage or retrieval system, or otherwise, without the prior written permission of SANYO Electric Co., Ltd.
- Any and all information described or contained herein are subject to change without notice due to product/technology improvement, etc. When designing equipment, refer to the "Delivery Specification" for the SANYO product that you intend to use.
- Information (including circuit diagrams and circuit parameters) herein is for example only; it is not guaranteed for volume production. SANYO believes information herein is accurate and reliable, but no guarantees are made or implied regarding its use or any infringements of intellectual property rights or other rights of third parties.

This catalog provides information as of October, 2000. Specifications and information herein are subject to change without notice.