



LA4270

6W Dual-Channel AF Power Amplifier

Features

- High-output dual-channel AF Power IC.
($P_O=6.0W \times 2$, $V_{CC}=25V$, $R_L=8\Omega$, $f=1kHz$, $THD=1.0\%$)
- Low distortion ($THD=0.1\%$, $V_{CC}=25V$, $R_L=8\Omega$, $f=1kHz$, $P_O=2W$).
- Minimum number of external parts required (no bootstrap capacitor required).
- Low pop noise at the time of power switch ON/OFF.
- High ripple rejection (58dB typ).
- Wide supply voltage range (10V to 32V).
- On-chip protector against abnormality (thermal shutdown, overvoltage).

Package Dimensions

unit:mm

3024A-SIP10H

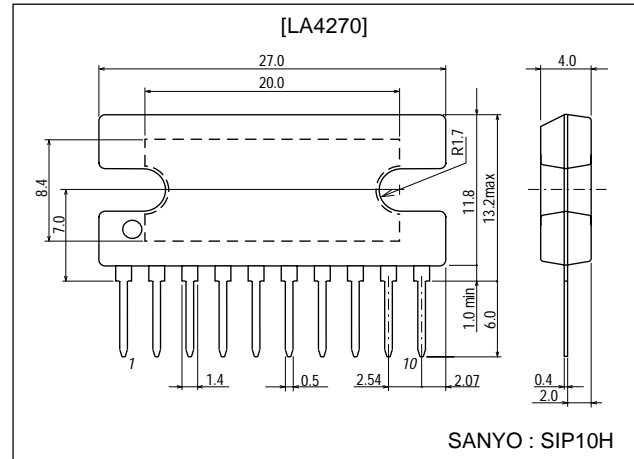

Specifications

Absolute Maximum Ratings at $T_a = 25^\circ C$

Parameter	Symbol	Conditions	Ratings	Unit
Maximum supply voltage	$V_{CC \text{ max}}$		35	V
Maximum output current	$I_O \text{ peak}$		3.5	V
Allowable power dissipation	$P_d \text{ max}$	With heat sink. See P_d - T_a graph.	20	W
Operating temperature	T_{opr}		-20 to +75	$^\circ C$
Storage temperature	T_{stg}		-40 to +150	$^\circ C$

Operating Conditions at $T_a = 25^\circ C$

Parameter	Symbol	Conditions	Ratings	Unit
Recommended supply voltage	V_{CC}		25	V
Operating voltage range	$V_{CC \text{ op}}$		10 to 32	V
Recommended load resistance	R_L		8	Ω

Operating Characteristics at $T_a = 25^\circ C$, $V_{CC}=25V$, $R_L=8\Omega$, $f=1kHz$, $R_g=600\Omega$, See specified test circuit

Parameter	Symbol	Conditions	Ratings			Unit
			min	typ	max	
Quiescent current	I_{CCO}		25	45	90	mA
Voltage gain	V_G		38	40	42	dB
Output power	P_O	$THD=1\%$	5.0	6.0		W
Total harmonic distortion	THD	$P_O=2W$		0.1	0.8	%
Output noise voltage	V_{NO}	$R_g=10k\Omega$, $BW=20Hz$ to $20kHz$		0.25	1.0	mV
Ripple rejection	$SVRR$	$R_g=10k\Omega$, $f_R=100Hz$, $V_R=0dBm$	45	58		dB

Continued on next page

■ Any and all SANYO products described or contained herein do not have specifications that can handle applications that require extremely high levels of reliability, such as life-support systems, aircraft's control systems, or other applications whose failure can be reasonably expected to result in serious physical and/or material damage. Consult with your SANYO representative nearest you before using any SANYO products described or contained herein in such applications.

■ SANYO assumes no responsibility for equipment failures that result from using products at values that exceed, even momentarily, rated values (such as maximum ratings, operating condition ranges, or other parameters) listed in products specifications of any and all SANYO products described or contained herein.

SANYO Electric Co., Ltd. Semiconductor Company

TOKYO OFFICE Tokyo Bldg., 1-10, 1 Chome, Ueno, Taito-ku, TOKYO, 110-8534 JAPAN

21500TH (KT)/40194HK/3210MO/8026KI/6126AT/6245KI, TS No.1724-1/9

LA4270

Continued from preceding page.

Parameter	Symbol	Conditions	Ratings			Unit
			min	typ	max	
Crosstalk	CT	$R_g=10k\Omega$	45	60		dB
Channel balance	ΔVG				1.5	dB

Equivalent Circuit Block Diagram and Pin Assignment

Unit (resistance: Ω)

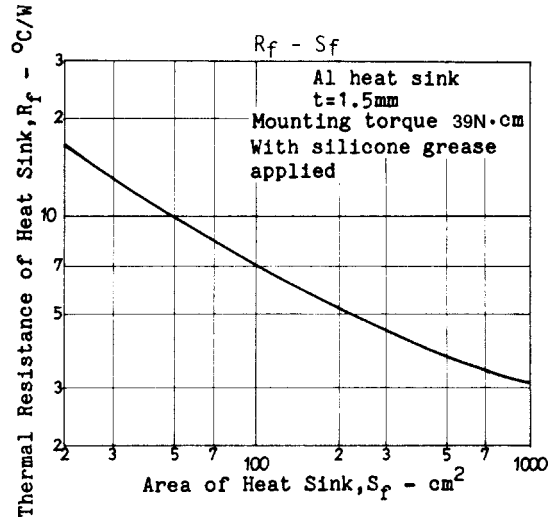
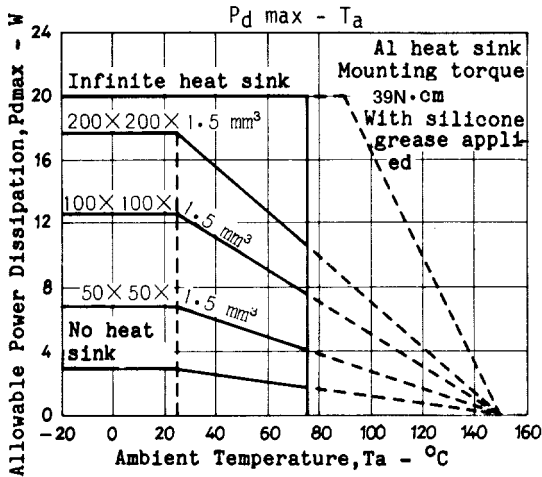
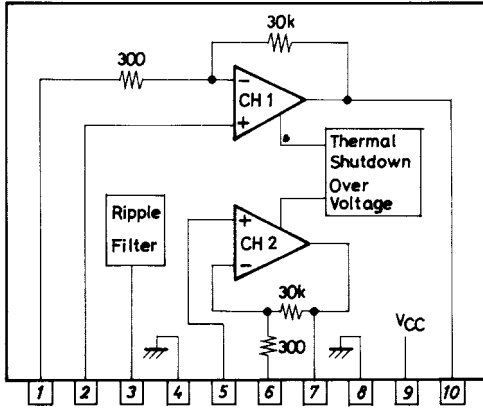

Sample Printed Circuit Pattern

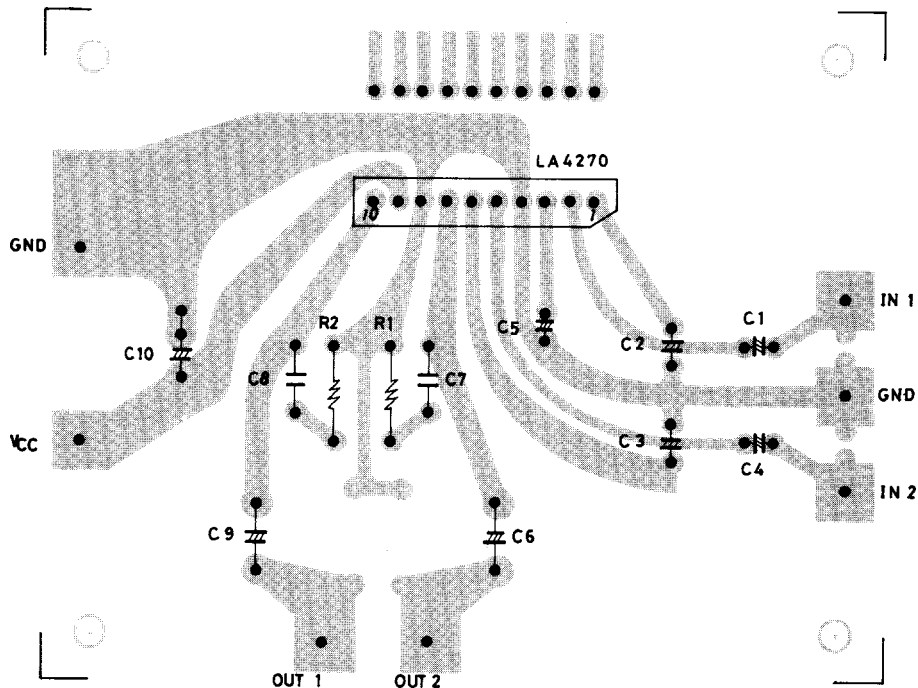

LA4270

Sample Application Circuit 1 : Dual-channel use (specified Test Circuit)

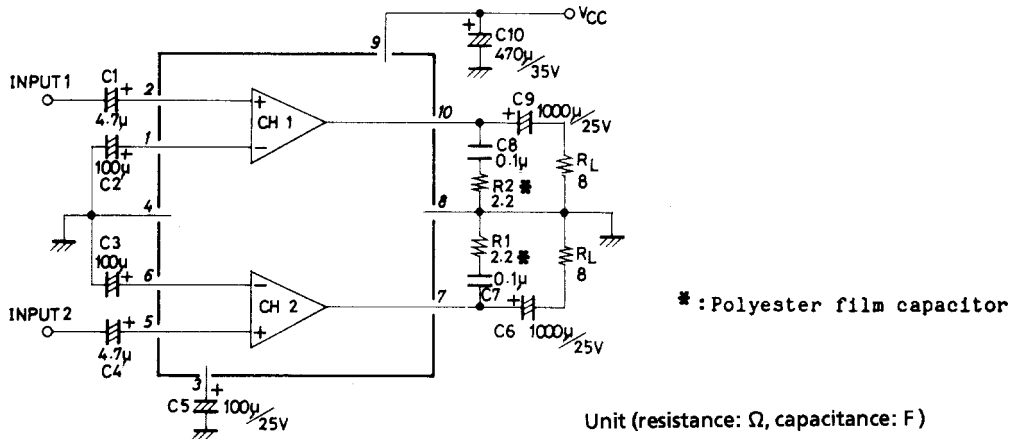

Description of External Parts

- C1, C4 : Input capacitors
(4.7μF) Since the DC potential of the input pins is not 0, the two capacitors cannot be omitted. Decreasing the capacitor value extremely causes the frequency response to lower at low frequencies.
- C2, C3 : Feedback capacitors
(100μF) Decreasing the capacitor value causes the frequency response to lower at low frequencies. Increasing the capacitor value makes the starting time later.
- C5 : Ripple filter capacitor
(100μF/25V) Decreasing the capacitor value provides less ripple rejection. Decreasing the capacitor value also makes the starting time earlier.
- C6, C9 : Output capacitors
(1000μF/25V) Decreasing the capacitor value provides less power at low frequencies.
- C7, C8 : Oscillation blocking capacitors
(0.1μF polyester film capacitors) Decreasing the capacitor value causes oscillation to be liable to occur. It is recommended to use polyester film capacitors which are excellent in high frequency response, temperature characteristic. The use of electrolytic capacitors or ceramic capacitors may cause oscillation to occur at low temperatures.
- C10 : Power capacitor
(470μF/35V) Decreasing the capacitor value causes ripple to be liable to occur. If the distance between the IC and this capacitor is made long or this capacitor is removed, oscillation may occur.
- R1, R2 : Resistors connected in series with oscillation blocking capacitors
(2.2Ω) Used to prevent phase shift attributable to the oscillation blocking capacitors so that oscillation is hard to occur. Increasing or decreasing the resistor value causes oscillation to be liable to occur. The optimum value must be used.

External Muting

1. Lowering of potential at ripple filter pin (pin 3).
Muting can be provided by discharging resistor R connected across pin 3 and GND to lower the potential at pin 3. Too small an R value causes pop noise to occur ; and too large an R value causes muting to fail to work.
If no adequate R value is obtained, it is recommended that the R value is made rather small and the C5 value is increased.

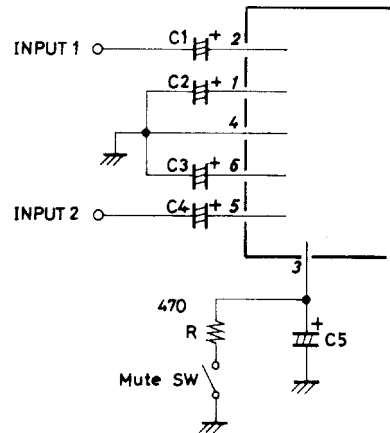

2. Application of positive bias to NF pins.
Muting can be provided by positive bias applied to the NF pins. In this case, the R value must be determined so that the potential at the NF pins (pins 1, 6) does not exceed 3V at the muting mode.

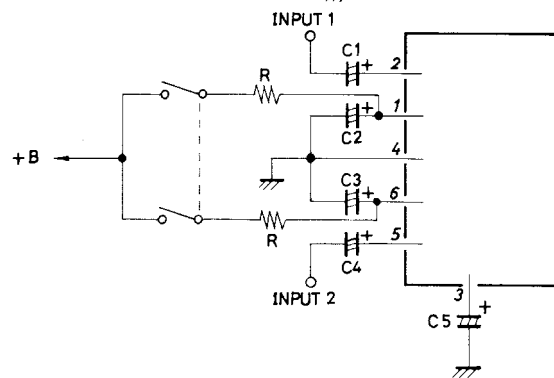

Voltage Gain

The voltage gain is fixed to 40dB by the ratio of on-chip resistors 30kΩ and 300Ω. It is impossible to use the IC at a voltage gain greater than this. In an application where the IC is used at a voltage gain of less than 40dB, resistors are connected in series with feedback resistors as shown right. In this application, however, oscillation is liable to occur. So, the voltage gain must not be less than 30dB.

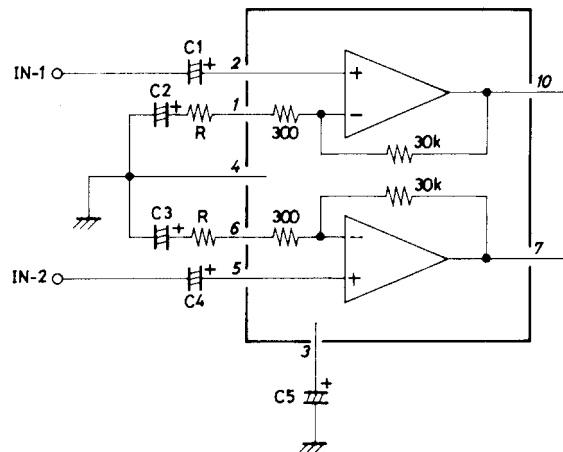

Sample Application Circuit 2 : Bridge amplifier use

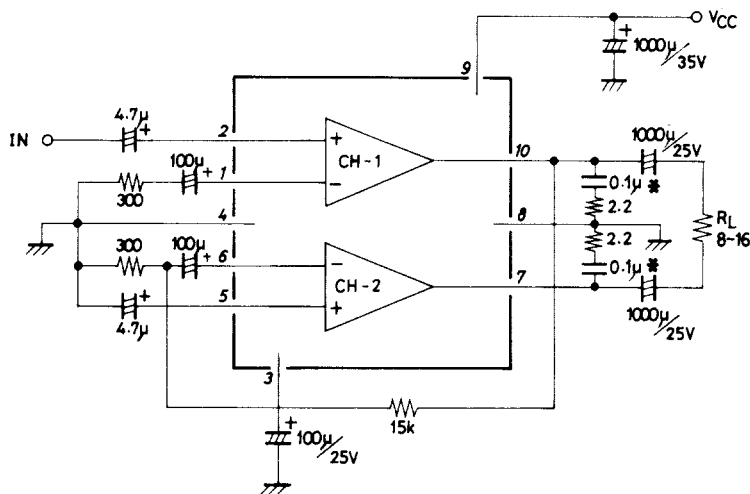

* : Polyester film capacitor

Unit (resistance: Ω, capacitance: F)

LA4270

In this application, output capacitors must be used. Since the IC handles an apparent load of 4Ω , more distortion results, making it impossible for the IC to deliver power at THD=1% as in 2-channel use. It is possible for the IC to deliver power at THD=5% or 10%

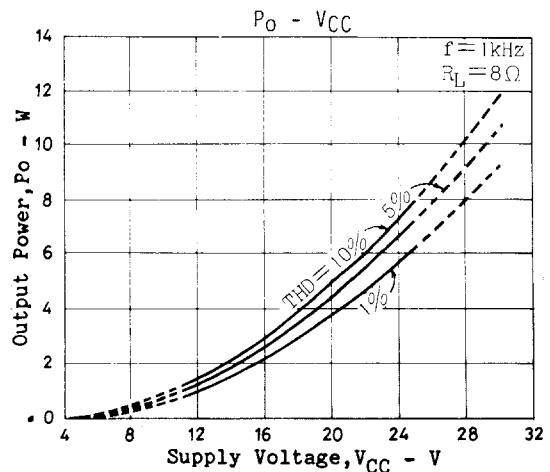
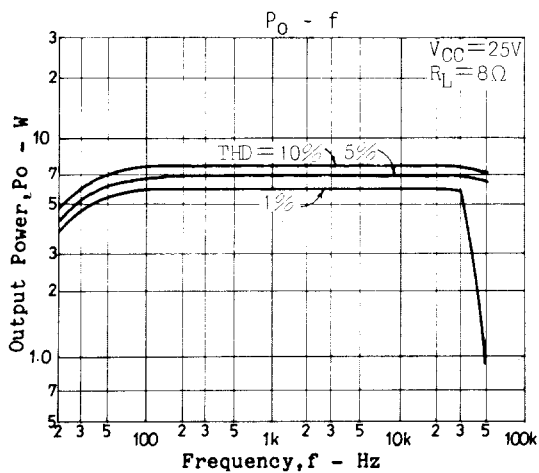
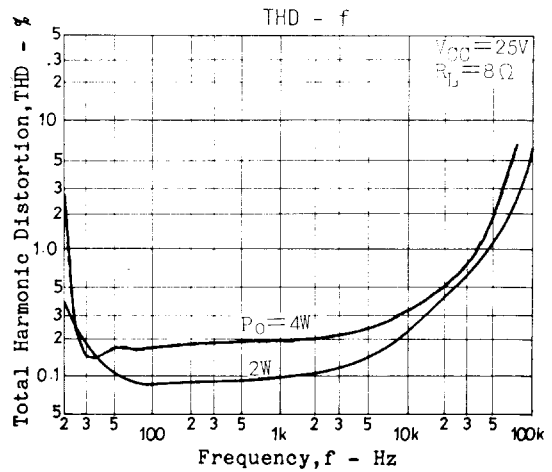
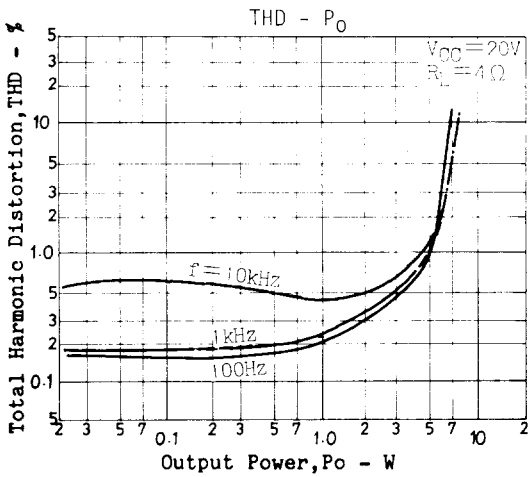
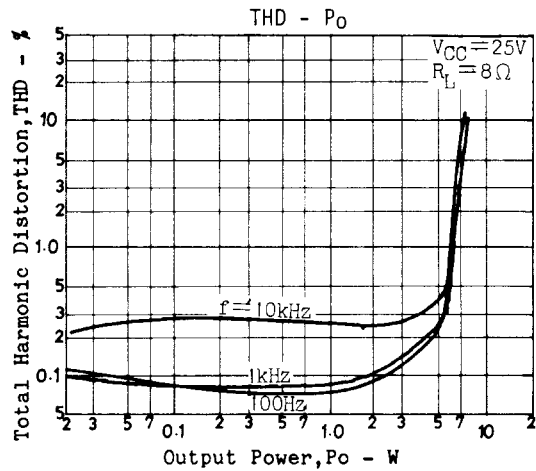
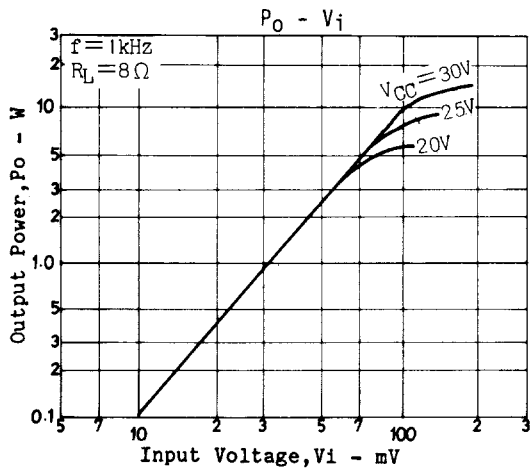

LA4270

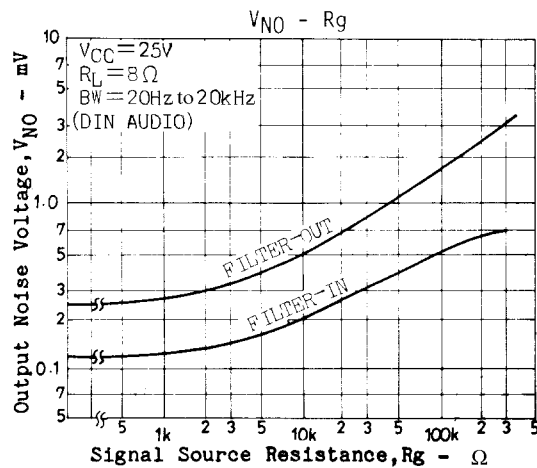
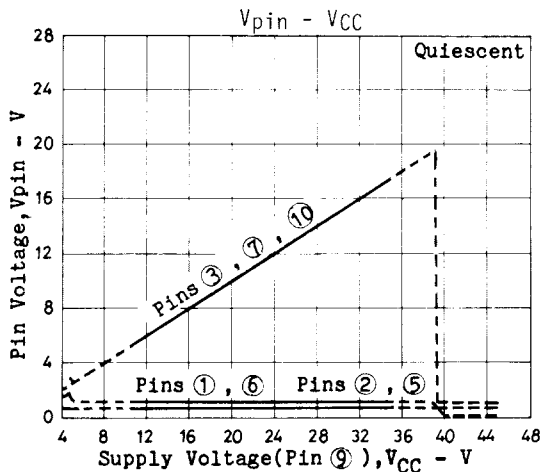
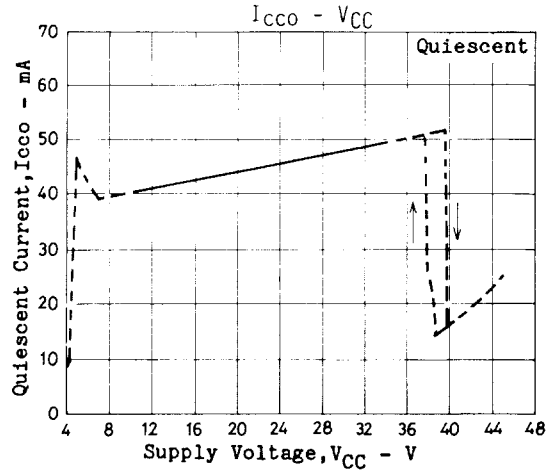
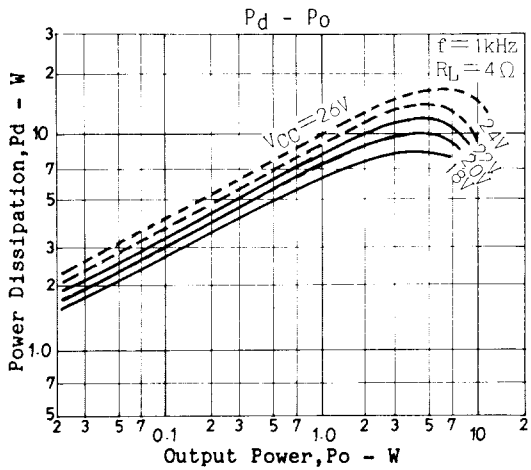
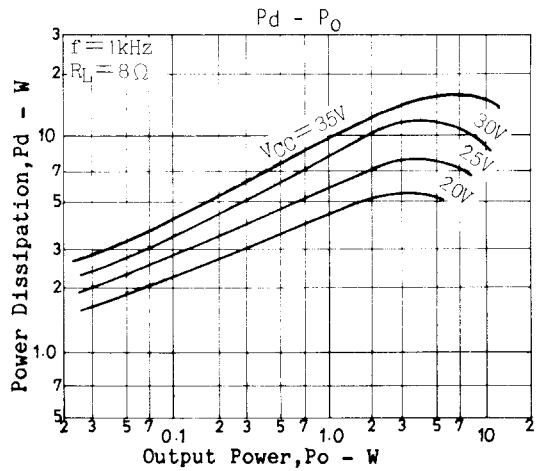
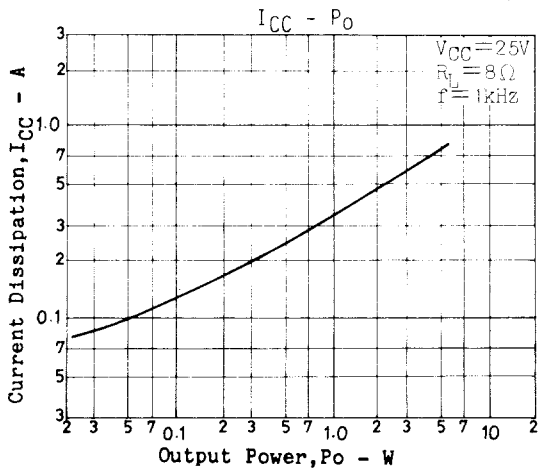
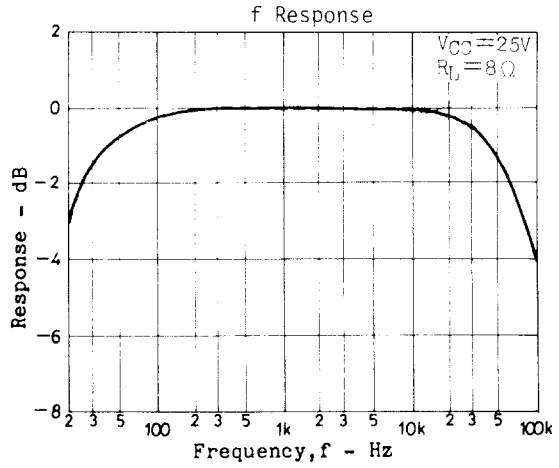
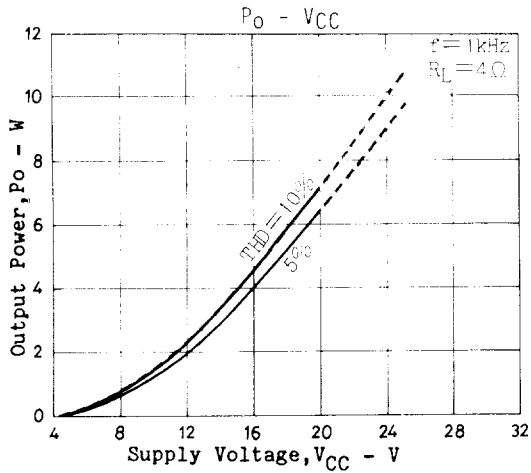

LA4270

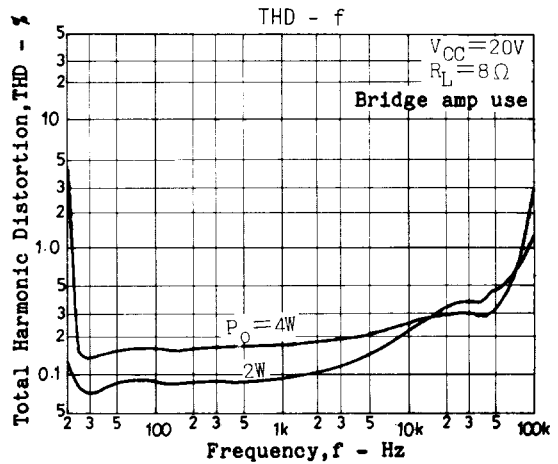
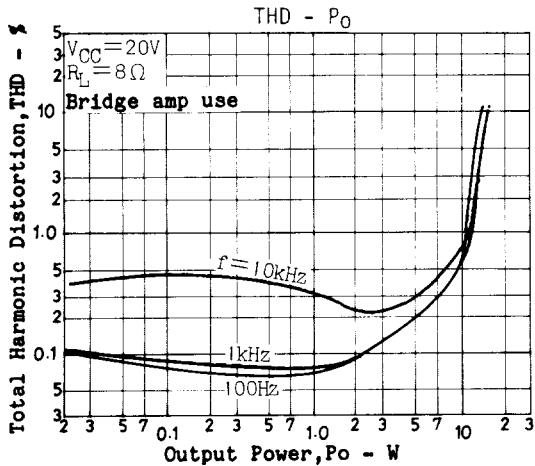
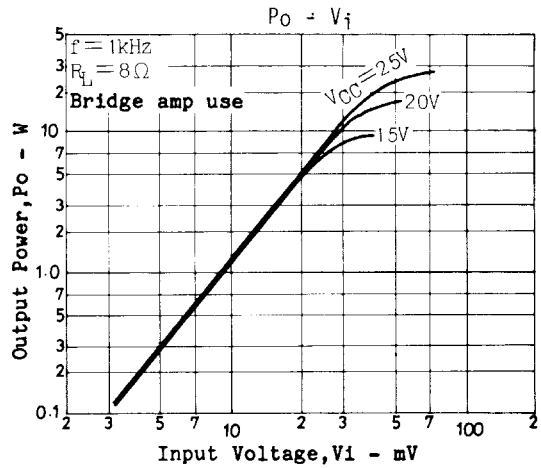
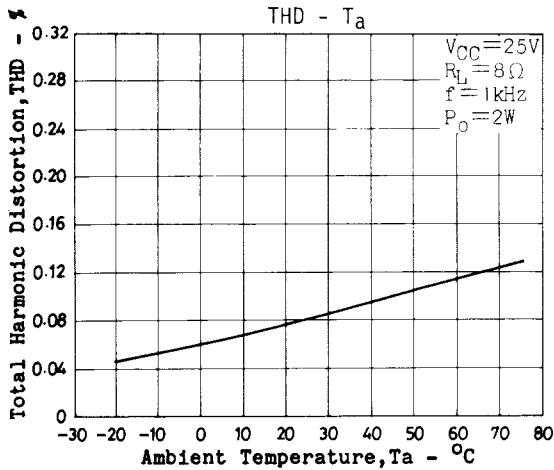
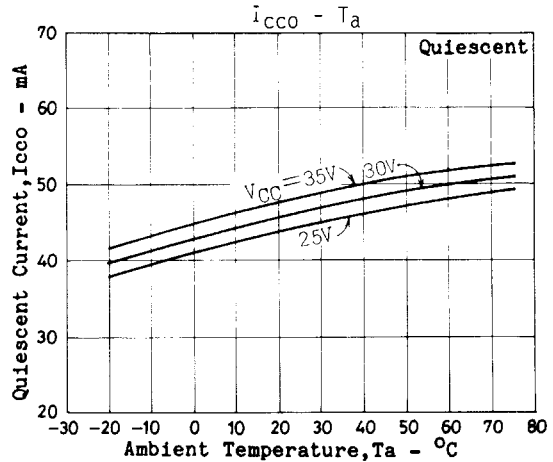
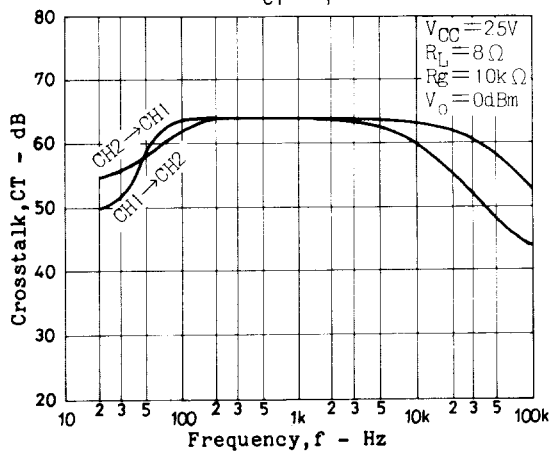
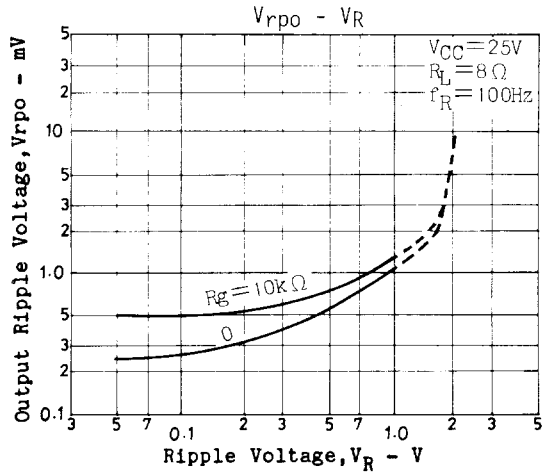
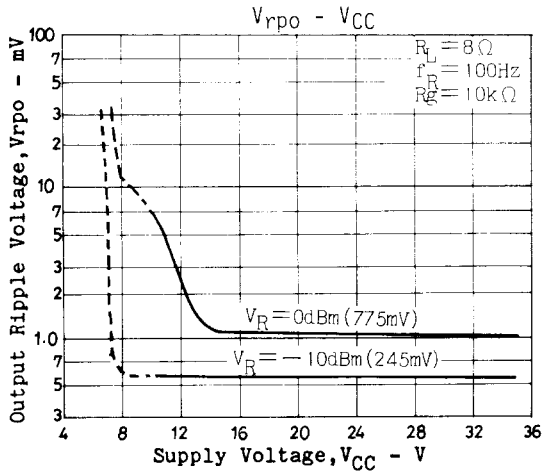

LA4270

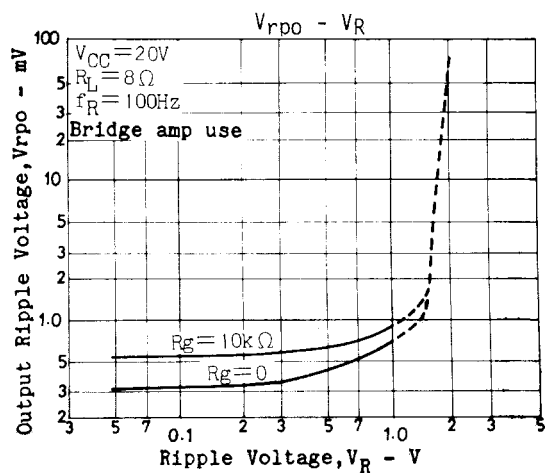
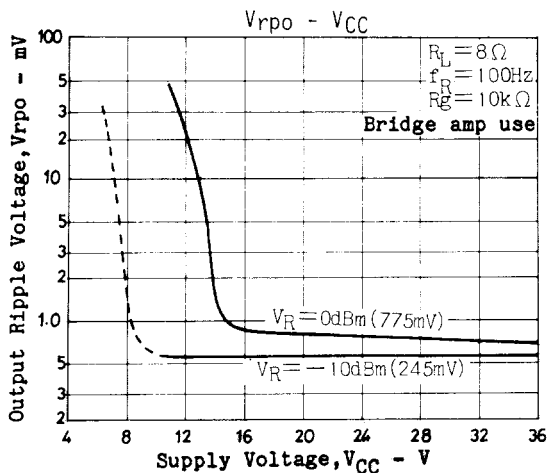
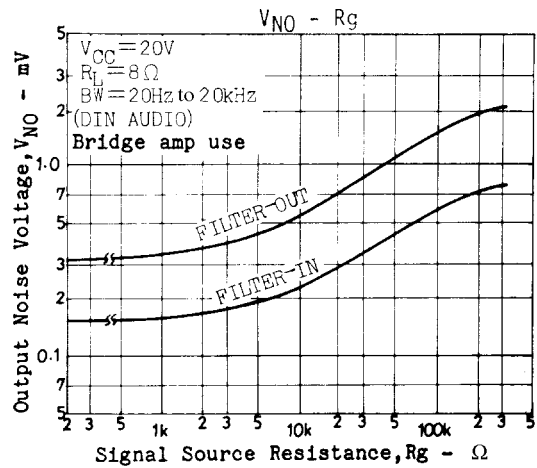
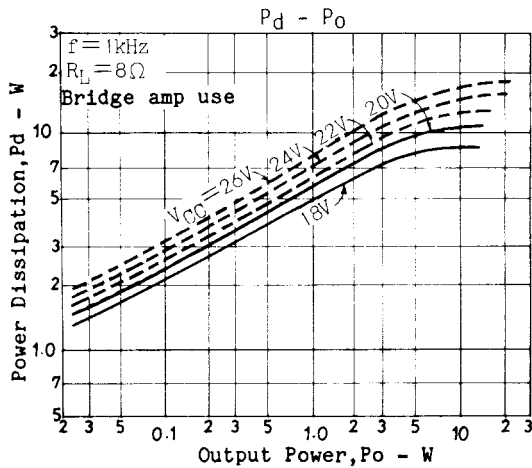
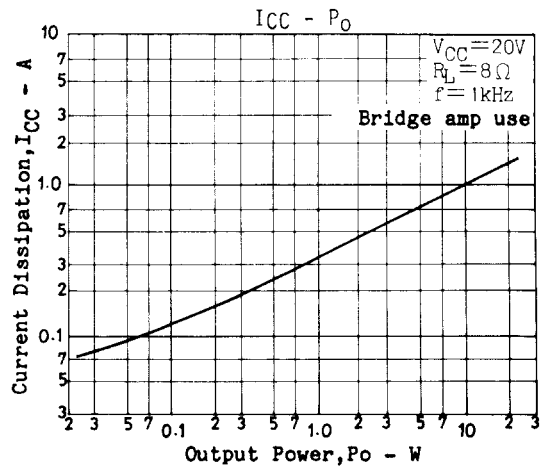
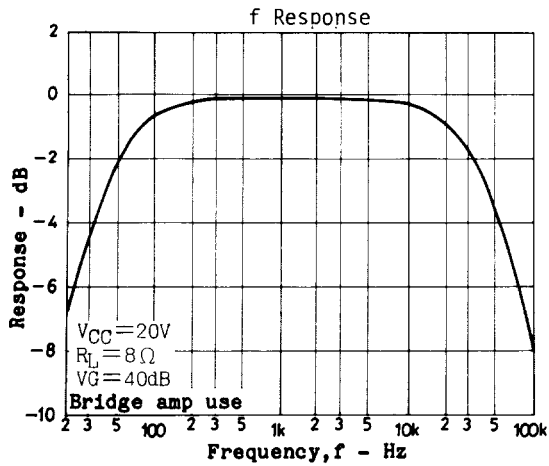
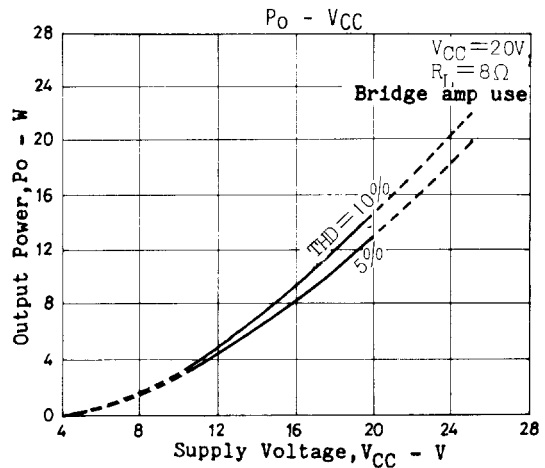
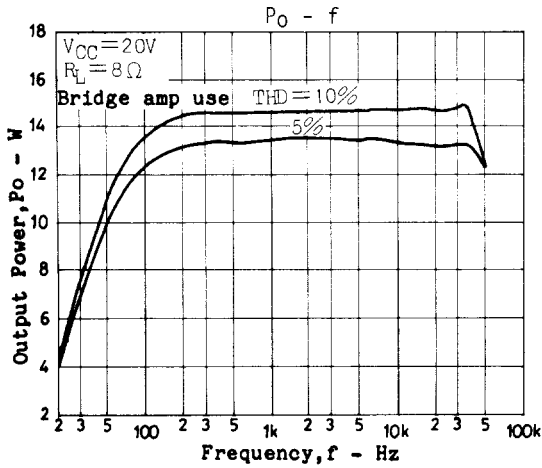

Proper Cases in Using IC

- Maximum ratings : If the IC is used in the vicinity of the maximum ratings, even a slight variation in conditions may cause the maximum ratings to be exceeded, thereby leading to breakdown. Allow an ample margin of variation for supply voltage, etc. and use the IC in the range where the maximum ratings are not exceeded.
- Pin-to-pin short : If power is applied when the space between pins is shorted, breakdown or deterioration may occur. When mounting the IC on the board or applying power, make sure that the space between pins is not shorted with solder, etc.
- When used in radio applications : When using in radios, allow a good distance between IC and bar antenna.
- Printed circuit pattern : When drawing the printed circuit pattern, make the power supply, output, and ground lines thick and short and arrange the pattern and parts so that no feedback loop is formed between input and output. Place power capacitor C10, oscillation blocking capacitors C7, C8 as close to IC pins as possible to prevent oscillation from occurring. Refer to the sample printed circuit pattern.

Proper Cares Mounting Radiator Fin

1. The mounting torque is in the range of 39 to 59N · cm.
2. The distance between screw holes of the radiator fin must coincide with the distance between screw holes of the IC. With case outline dimensions L and R referred to, the screws must be tightened with the distance between them as close to each other as possible.

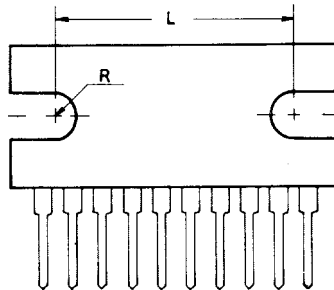

3. The screw to be used must have a head equivalent to the truss machine screw or binder machine screw defined by JIS. Washers must be also used to protect the IC case.
4. No foreign matter such as cutting particles shall exist between heat sink and radiator fin. When applying grease on the junction surface, it must be applied uniformly on the whole surface.
5. IC lead pins are soldered to the printed circuit board after the radiator fin is mounted on the IC.

- Specifications of any and all SANYO products described or contained herein stipulate the performance, characteristics, and functions of the described products in the independent state, and are not guarantees of the performance, characteristics, and functions of the described products as mounted in the customer's products or equipment. To verify symptoms and states that cannot be evaluated in an independent device, the customer should always evaluate and test devices mounted in the customer's products or equipment.
- SANYO Electric Co., Ltd. strives to supply high-quality high-reliability products. However, any and all semiconductor products fail with some probability. It is possible that these probabilistic failures could give rise to accidents or events that could endanger human lives, that could give rise to smoke or fire, or that could cause damage to other property. When designing equipment, adopt safety measures so that these kinds of accidents or events cannot occur. Such measures include but are not limited to protective circuits and error prevention circuits for safe design, redundant design, and structural design.
- In the event that any or all SANYO products(including technical data, services) described or contained herein are controlled under any of applicable local export control laws and regulations, such products must not be exported without obtaining the export license from the authorities concerned in accordance with the above law.
- No part of this publication may be reproduced or transmitted in any form or by any means, electronic or mechanical, including photocopying and recording, or any information storage or retrieval system, or otherwise, without the prior written permission of SANYO Electric Co., Ltd.
- Any and all information described or contained herein are subject to change without notice due to product/technology improvement, etc. When designing equipment, refer to the "Delivery Specification" for the SANYO product that you intend to use.
- Information (including circuit diagrams and circuit parameters) herein is for example only ; it is not guaranteed for volume production. SANYO believes information herein is accurate and reliable, but no guarantees are made or implied regarding its use or any infringements of intellectual property rights or other rights of third parties.

This catalog provides information as of February, 2000. Specifications and information herein are subject to change without notice.

This datasheet has been download from:

www.datasheetcatalog.com

Datasheets for electronics components.