

DC MOTOR SPEED CONTROLLER

The KA2401 is a monolithic integrated circuit designed for DC motor speed controllers.

FEATURES

- Suitable for DC motor speed controllers of cassette tape recorders and radio cassettes.
- Excellent stability of each characteristics against ambient temperature.
- Low quiescent current (0.8mA; Typ).
- Low reference voltage.
- Wide operating supply voltage range (4V ~ 12V).

8 DIP

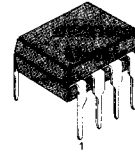

ORDERING INFORMATION

Device	Package	Operating Temperature
KA2401	8 DIP	- 20°C ~ + 70°C

BLOCK DIAGRAM

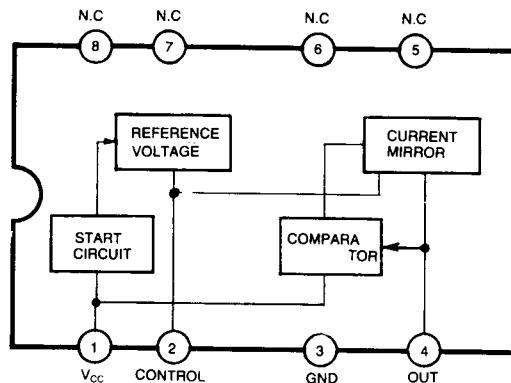

Fig. 1

ABSOLUTE MAXIMUM RATINGS ($T_a = 25^\circ\text{C}$)

Characteristic	Symbol	Value	Unit
Supply Voltage	V_{CC}	16	V
Circuit Current	I_4	2	A
Power Dissipation	P_D	600	mW
Operating Temperature	T_{OPR}	-20 ~ +70	$^\circ\text{C}$
Storage Temperature	T_{STG}	-40 ~ +125	$^\circ\text{C}$

*t < 5 sec

ELECTRICAL CHARACTERISTICS

(Ta = 25°C, V_{CC} = 6V, unless otherwise specified)

Characteristic	Symbol	Test Conditions	Min	Typ	Max	Unit	Test Fig
Reference Voltage	V_{REF}	$I_4 = 10\text{mA}$	1.10	1.27	1.40	V	2
Quiescent Circuit Current	I_{CCQ}	$R_M = 180\Omega$	0.5	0.8	1.2	mA	5
Current Coefficient	K	$R_{M1} = 44\Omega, R_{M2} = 33\Omega$	18	20	22		3
Saturation Voltage	$V_4 (SAT)$	$V_{CC} = 4.2\text{V}, R_M = 4.4\Omega$		1.5	20	V	4
Voltage Characteristic of Shunt-Current Coefficient	$\frac{\Delta K}{K} / \Delta V_{CC}$	$I_4 = 100\text{mA}, V_{CC} = 4 \sim 12\text{V}$		0.4		%/V	3
Voltage Characteristic of Reference Voltage	$\frac{\Delta V_{REF}}{V_{REF}} / \Delta V_{CC}$	$I_4 = 100\text{mA}, V_{CC} = 4 \sim 12\text{V}$		0.6		%/V	2
Current Characteristic of Current Coefficient	$\frac{\Delta K}{K} / \Delta I_4$	$I_4 = 30 \sim 200\text{mA}$		-0.02		%/mA	3
Current Characteristic of Reference Voltage	$\frac{\Delta V_{REF}}{V_{REF}} / \Delta I_4$	$I_4 = 30 \sim 200\text{mA}$		-0.02		%/mA	2
Temperature Characteristic of Current Coefficient	$\frac{\Delta K}{K} / \Delta T_a$	$I_4 = 100\text{mA}$ $T_a = -20 \sim +75^\circ\text{C}$		0.01		%/°C	3
Temperature Characteristic of Reference Voltage	$\frac{\Delta V_{REF}}{V_{REF}} / \Delta T_a$	$I_4 = 100\text{mA}$ $T_a = -20 \sim +75^\circ\text{C}$		0.01		%/°C	2

TEST CIRCUIT 1

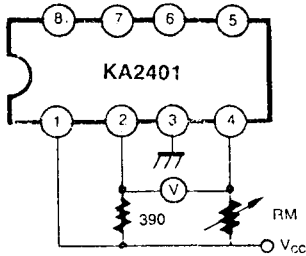

Fig. 2

$$V_{ref}, \frac{\Delta V_{REF}}{V_{REF}} / \Delta V_{CC}, \frac{\Delta V_{REF}}{V_{REF}} / \Delta I_4, \frac{\Delta V_{REF}}{V_{REF}} / \Delta T_a$$

TEST CIRCUIT 2

Current Coefficient

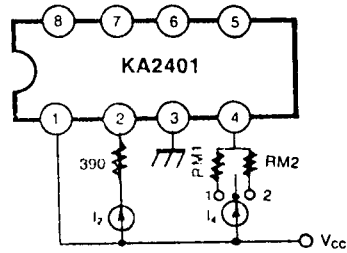

Fig. 3

$$K, \frac{\Delta K}{K} / \Delta V_{CC}, \frac{\Delta K}{K} / \Delta I_4, \frac{\Delta K}{K} / \Delta T_a$$

$$K = \frac{I_4 (SW 2) - I_4 (SW 1)}{I_2 (SW 2) - I_2 (SW 1)}$$

TEST CIRCUIT 3

Saturation Voltage

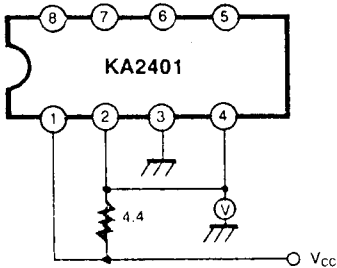

Fig. 4

TEST CIRCUIT 4

Quiescent Circuit Current

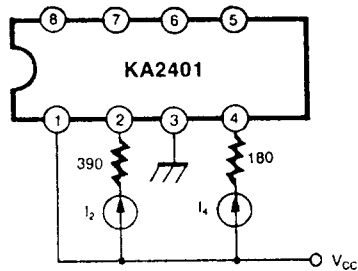
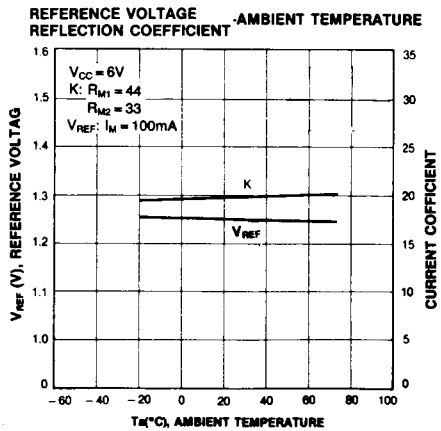
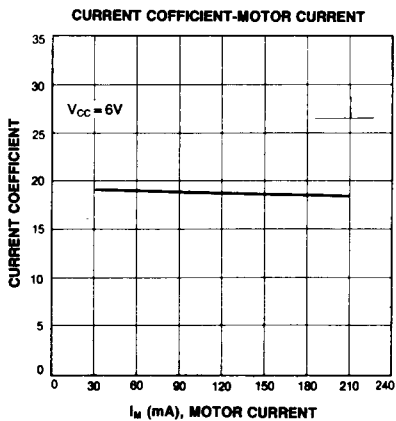
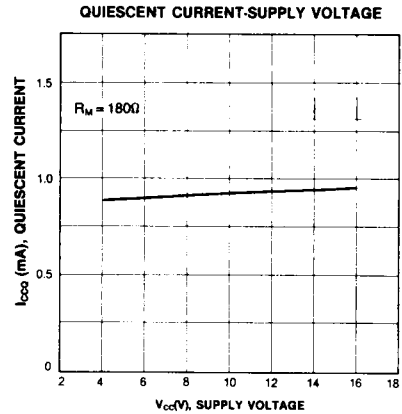
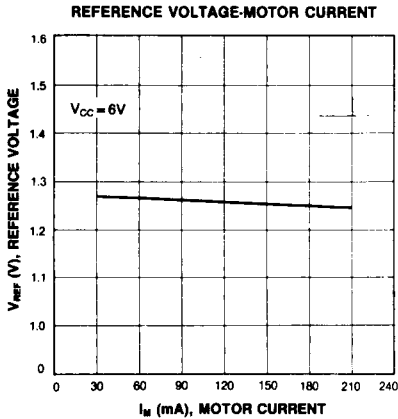
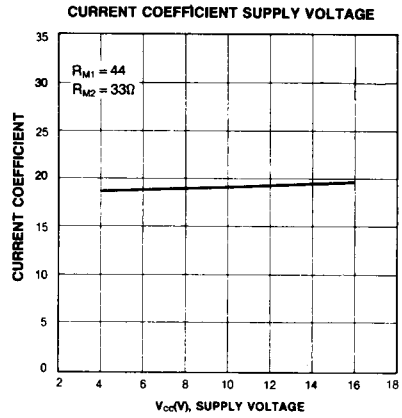
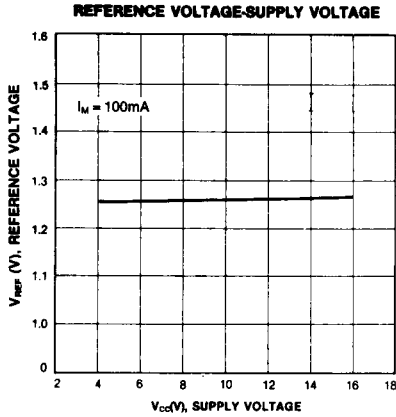
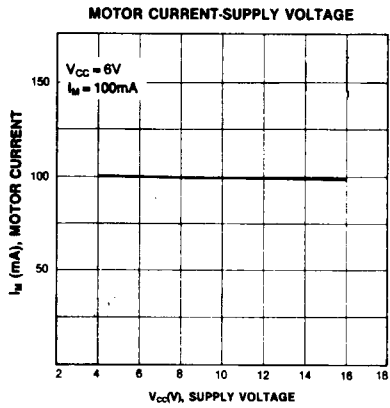

Fig. 5





3

APPLICATION CIRCUIT

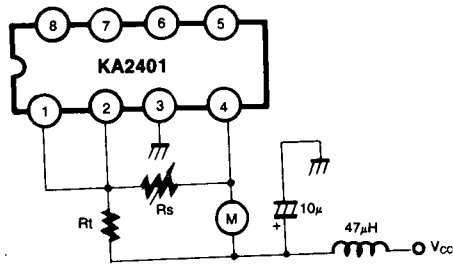

Fig. 6

This datasheet has been download from:

www.datasheetcatalog.com

Datasheets for electronics components.