

Silicon NPN Power Transistors

2SD1667

DESCRIPTION

- With TO-220F package
- Complement to type 2SB1134
- Low collector saturation voltage

APPLICATIONS

- Relay drivers,high-speed inverters,and other general high-current switching applications

PINNING

PIN	DESCRIPTION
1	Base
2	Collector
3	Emitter

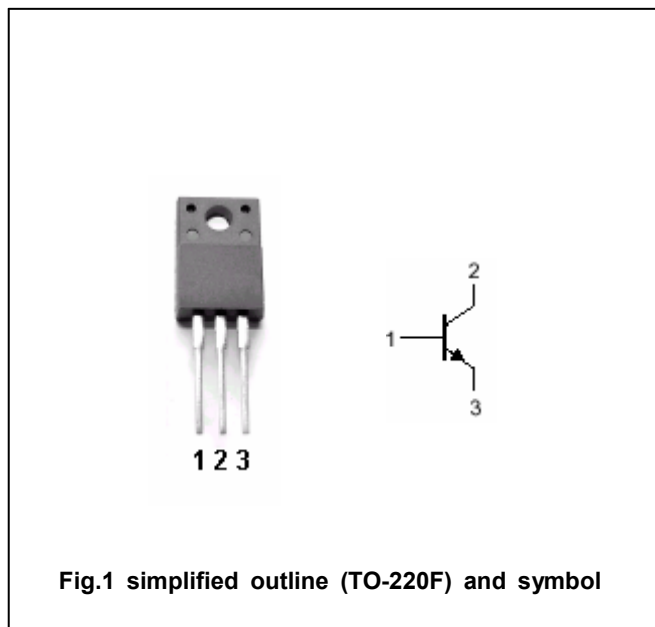

Fig.1 simplified outline (TO-220F) and symbol

Absolute maximum ratings (Ta=25°C)

SYMBOL	PARAMETER	CONDITIONS	MAX	UNIT
V _{CBO}	Collector-base voltage	Open emitter	60	V
V _{CEO}	Collector-emitter voltage	Open base	50	V
V _{EBO}	Emitter-base voltage	Open collector	6	V
I _C	Collector current		5	A
I _{CM}	Collector current-peak		9	A
P _C	Collector dissipation	T _a =25°C	2	W
		T _C =25°C	25	
T _j	Junction temperature		150	°C
T _{stg}	Storage temperature		-55~150	°C

Silicon NPN Power Transistors

2SD1667

CHARACTERISTICS

T_j=25°C unless otherwise specified

SYMBOL	PARAMETER	CONDITIONS	MIN	TYP.	MAX	UNIT
V _{(BR)CEO}	Collector-emitter breakdown voltage	I _C =1mA ; R _{BE} =∞	50			V
V _{(BR)CBO}	Collector-base breakdown voltage	I _C =1mA ; I _E =0	60			V
V _{(BR)EBO}	Emitter-base breakdown voltage	I _E =1mA ; I _C =0	6			V
V _{CEsat}	Collector-emitter saturation voltage	I _C =3A ; I _B =0.3A			0.4	V
I _{CBO}	Collector cut-off current	V _{CB} =40V ; I _E =0			100	μA
I _{EBO}	Emitter cut-off current	V _{EB} =4V ; I _C =0			100	μA
h _{FE-1}	DC current gain	I _C =1A ; V _{CE} =2V	70		280	
h _{FE-2}	DC current gain	I _C =3A ; V _{CE} =2V	30			
C _{OB}	Output capacitance	I _E =0 ; V _{CB} =10V ; f=1MHz		100		pF
f _T	Transition frequency	I _C =1A ; V _{CE} =5V		30		MHz

Switching times

t _{on}	Turn-on time	I _C =2.0A ; I _{B1} =-I _{B2} =0.2A V _{CC} =20V ; R=10Ω		0.1		μs
t _s	Storage time			1.4		μs
t _f	Fall time			0.2		μs

◆ h_{FE-1} Classifications

Q	R	S
70-140	100-200	140-280

Silicon NPN Power Transistors

2SD1667

PACKAGE OUTLINE

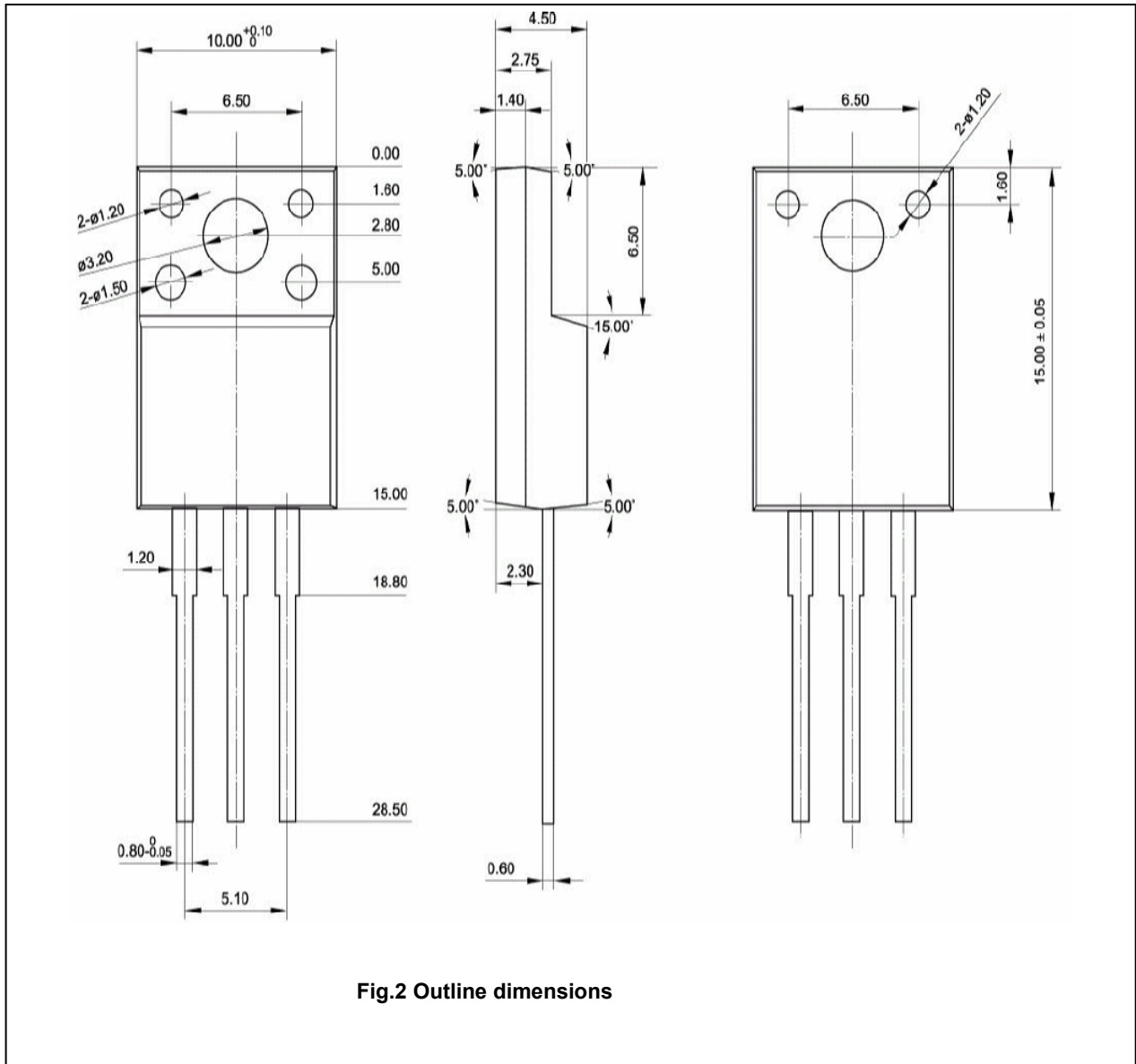

Fig.2 Outline dimensions

Silicon NPN Power Transistors

2SD1667

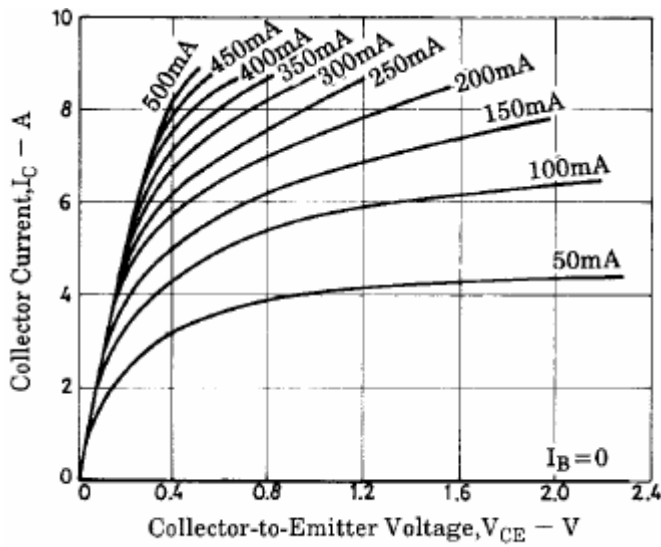

Fig.3 Static Characteristic

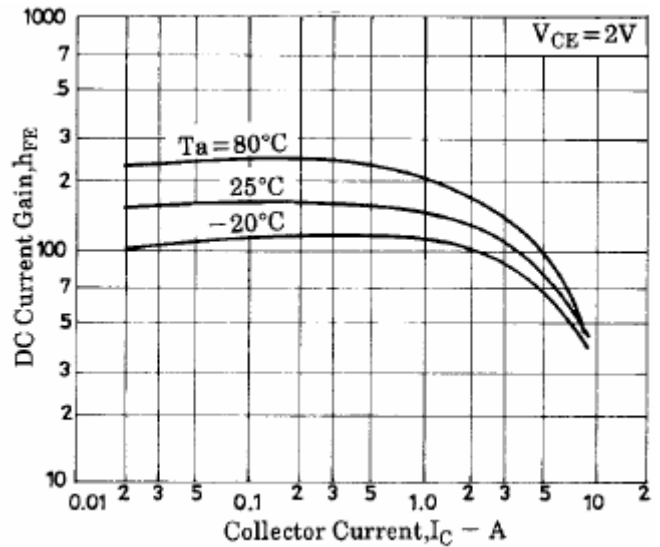

Fig.4 DC current Gain

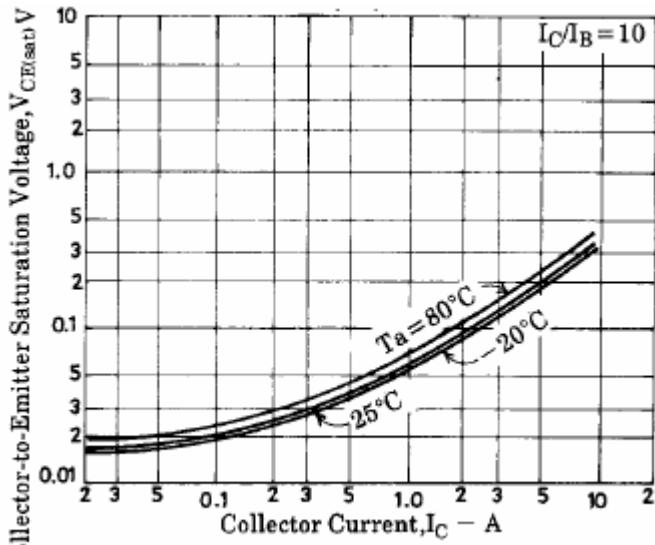

Fig.5 Collector-Emmitter Saturation Voltage

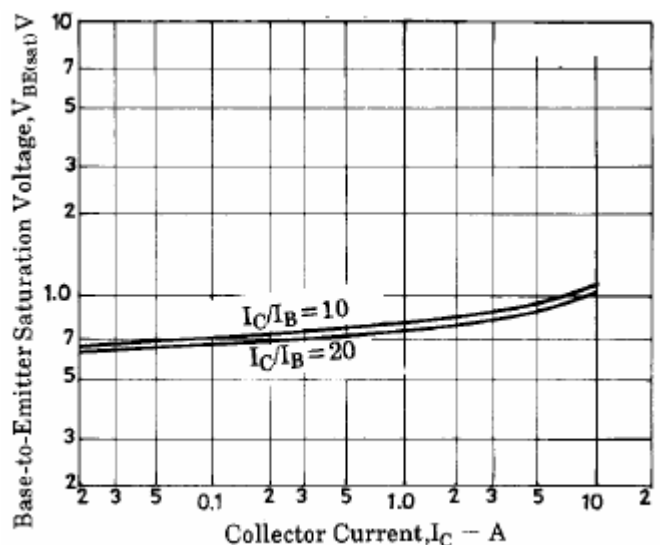

Fig.6 Base-Emmitter Saturation Voltage

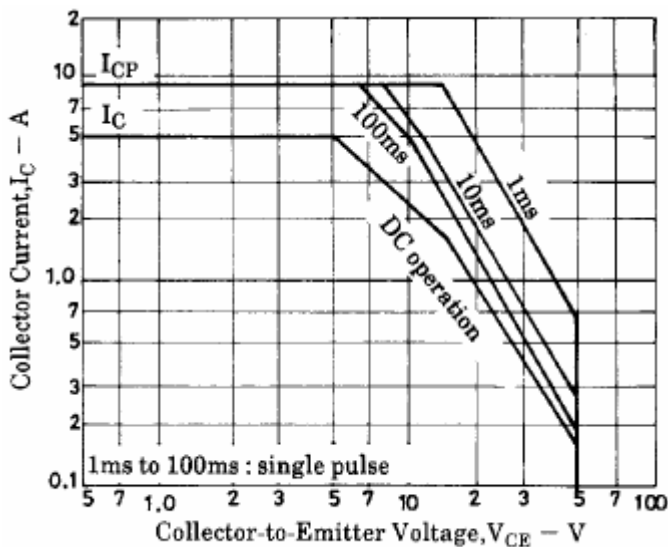

Fig.7 Safe Operating Area