

LMV721/LMV722

10MHz, Low Noise, Low Voltage, and Low Power Operational Amplifier

General Description

The LMV721 (Single) and LMV722 (Dual) are low noise, low voltage, and low power op amps, that can be designed into a wide range of applications. The LMV721/LMV722 has a unity gain bandwidth of 10MHz, a slew rate of 5V/us, and a quiescent current of 930uA/amplifier at 2.2V.

The LMV721/722 are designed to provide optimal performance in low voltage and low noise systems. They provide rail-to-rail output swing into heavy loads. The input common-mode voltage range includes ground, and the maximum input offset voltage are 3.5mV (Over Temp.) for the LMV721/LMV722. Their capacitive load capability is also good at low supply voltages. The operating range is from 2.2V to 5.5V.

The chip is built with National's advanced Submicron Silicon-Gate BiCMOS process. The single version, LMV721, is available in 5 pin SOT23-5 and a SC-70 (new) package. The dual version, LMV722, is available in a SO-8 and MSOP-8 package.

Features

(For Typical, 5 V Supply Values; Unless Otherwise Noted)

- Guaranteed 2.2V and 5.0V Performance
- Low Supply Current LMV721/2 930uA/amplifier @2.2V
- High Unity-Gain Bandwidth 10MHz
- Rail-to-Rail Output Swing
 - @600Ω load 120mV from either rail at 2.2V
 - @2kΩ load 50mV from either rail at 2.2V
- Input Common Mode Voltage Range Includes Ground
- Silicon Dust™, SC70-5 Package 2.0x2.0x1.0 mm
- Input Voltage Noise $9 \frac{nV}{\sqrt{Hz}}$ @ f = 1KHz

Applications

- Cellular an Cordless Phones
- Active Filter and Buffers
- Laptops and PDAs
- Battery Powered Electronics

Connection Diagrams

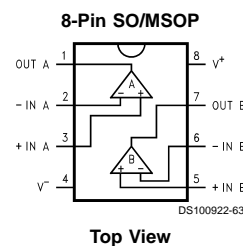
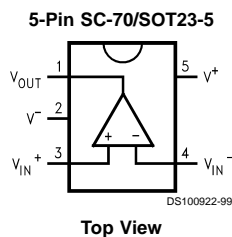

Silicon Dust™ is a trademark of National Semiconductor Corporation.

Ordering Information

Package	Temperature Range	Packaging Marking	Transport Media	NSC Drawing
	Industrial -40°C to +85°C			
8-Pin Small Outline	LMV722M	LMV722M	Rails	M08A
	LMV722MX	LMV722M	2.5K Units Tape and Reel	
8-pin MSOP	LMV722MM	LMV722	1K Units Tape and Reel	MUA08A
	LMV722MMX	LMV722	3.5K Units Tape and Reel	
5-Pin SOT23	LMV721M5	A30A	1K Units Tape and Reel	M05B
	LMV721M5X	A30A	3K Units Tape and Reel	
5-Pin SC-70	LMV721M7	A20	1K Units Tape and Reel	MAA05A
	LMV721M7X	A20	3K Units Tape and Reel	

Absolute Maximum Ratings (Note 1)

If Military/Aerospace specified devices are required, please contact the National Semiconductor Sales Office/Distributors for availability and specifications.

ESD Tolerance (Note 2)	
Human Body Model	2000V
Machine Model	200V
Differential Input Voltage	± Supply Voltage
Supply Voltage ($V^+ - V^-$)	5.5V
Soldering Information	
Infrared or Convection (20 sec.)	235°C
Storage Temp. Range	-65°C to 150°C
Junction Temperature (Note 4)	150°C

Operating Ratings (Note 3)

Supply Voltage	2.2V to 5.0V
Temperature Range	-40°C ≤ T _J ≤ 85°C
Thermal Resistance (θ _{JA})	
Silicon Dust SC70-5 Pkg	440 °C/W
Tiny SOT23-5 Pkg	265 °C/W
SO Pkg, 8-pin Surface Mount	190 °C/W
MSOP Pkg, 8-Pin Mini Surface Mount	235 °C/W
SO Pkge, 14-Pin Surface Mount	145 °C/W

2.2V DC Electrical Characteristics

Unless otherwise specified, all limits guaranteed for T_J = 25°C. V⁺ = 2.2V, V⁻ = 0V, V_{CM} = V⁺/2, V_O = V⁺/2 and R_L > 1 MΩ. **Boldface** limits apply at the temperature extremes.

Symbol	Parameter	Condition	Typ (Note 5)	Limit (Note 6)	Units
V _{OS}	Input Offset Voltage		0.02	3 3.5	mV max
TCV _{OS}	Input Offset Voltage Average Drift		0.6		µV/°C
I _B	Input Bias Current		260		nA
I _{OS}	Input Offset Current		25		nA
CMRR	Common Mode Rejection Ratio	0V ≤ V _{CM} ≤ 1.3V	88	70 64	dB min
PSRR	Power Supply Rejection Ratio	2.2V ≤ V ⁺ ≤ 5V, V _O = 0 V _{CM} = 0	90	70 64	dB min
V _{CM}	Input Common-Mode Voltage Range	For CMRR ≥ 50dB	-0.30		V
			1.3		V
A _V	Large Signal Voltage Gain	R _L =600Ω V _O = 0.75V to 2.00V	81	75 60	dB min
		R _L = 2kΩ V _O = 0.50V to 2.10V	84	75 60	dB min
V _O	Output Swing	R _L = 600Ω to V ⁺ /2	2.125	2.090 2.065	V min
			0.061	0.110 0.135	V max
		R _L = 2kΩ to V ⁺ /2	2.177	2.150 2.125	V min
			0.026	0.050 0.075	V max
I _O	Output Current	Sourcing, V _O = 0V V _{IN} (diff) = ± 0.5V	14.9	10.0 5.0	mA min
		Sinking, V _O = 2.2V V _{IN} (diff) = ± 0.5V	23.8	15.0 5.0	mA min
I _S	Supply Current	LMV721	0.93	1.2 1.5	mA max
		LMV722	1.64	2.2 2.6	

2.2V AC Electrical Characteristics

Unless otherwise specified, all limits guaranteed for $T_J = 25^\circ\text{C}$. $V^+ = 2.2\text{V}$, $V^- = 0\text{V}$, $V_{\text{CM}} = V^+/2$, $V_O = V^+/2$ and $R_L > 1\text{M}\Omega$. **Boldface** limits apply at the temperature extremes.

Symbol	Parameter	Conditions	Typ (Note 5)	Units
SR	Slew Rate	(Note 7)	4.9	V/ μs
GBW	Gain-Bandwidth Product		10	MHz
Φ_m	Phase Margin		67.4	Deg
G_m	Gain Margin		-9.8	dB
e_n	Input-Referred Voltage Noise	$f = 1\text{kHz}$	9	$\frac{\text{nV}}{\sqrt{\text{Hz}}}$
i_n	Input-Referred Current Noise	$f = 1\text{kHz}$	0.3	$\frac{\text{pA}}{\sqrt{\text{Hz}}}$
THD	Total Harmonic Distortion	$f = 1\text{kHz}$ $A_V = 1$ $R_L = 600\Omega$, $V_O = 500\text{mV}_{\text{PP}}$	0.004	%

5V DC Electrical Characteristics

Unless otherwise specified, all limits guaranteed for $T_J = 25^\circ\text{C}$. $V^+ = 5\text{V}$, $V^- = 0\text{V}$, $V_{\text{CM}} = V^+/2$, $V_O = V^+/2$ and $R_L > 1\text{M}\Omega$. **Boldface** limits apply at the temperature extremes.

Symbol	Parameter	Condition	Typ (Note 5)	Limit (Note 6)	Units
V_{OS}	Input Offset Voltage		-0.08	3 3.5	mV max
TCV_{OS}	Input Offset Voltage Average Drift		0.6		$\mu\text{V}/^\circ\text{C}$
I_B	Input Bias Current		260		nA
I_{OS}	Input Offset Current		25		nA
CMRR	Common Mode Rejection Ratio	$0\text{V} \leq V_{\text{CM}} \leq 4.1\text{V}$	89	70 64	dB min
PSRR	Power Supply Rejection Ratio	$2.2\text{V} \leq V^+ \leq 5.0\text{V}$, $V_O = 0$ $V_{\text{CM}} = 0$	90	70 64	dB min
V_{CM}	Input Common-Mode Voltage Range	For CMRR $\geq 50\text{dB}$	-0.30 4.1		V V
A_V	Large Signal Voltage Gain	$R_L = 600\Omega$ $V_O = 0.75\text{V}$ to 4.80V	87	80 70	dB min
		$R_L = 2\text{k}\Omega$, $V_O = 0.70\text{V}$ to 4.90V ,	94	85 70	dB min
V_O	Output Swing	$R_L = 600\Omega$ to $V^+/2$	4.882	4.840 4.140	V min V max
			0.105	0.160 0.185	V max
		$R_L = 2\text{k}\Omega$ to $V^+/2$	4.962	4.940 4.915	V min
			0.046	0.080 0.105	V max
I_O	Output Current	Sourcing, $V_O = 0\text{V}$ $V_{\text{IN}}(\text{diff}) = \pm 0.5\text{V}$	52.6	25.0 12.0	mA min
		Sinking, $V_O = 5\text{V}$ $V_{\text{IN}}(\text{diff}) = \pm 0.5\text{V}$	23.7	15.0 8.5	mA min
I_S	Supply Current	LMV721	1.03	1.4 1.7	mA
		LMV722	1.83	2.4 2.8	mA max

5V AC Electrical Characteristics

Unless otherwise specified, all limits guaranteed for $T_J = 25^\circ\text{C}$. $V^+ = 5\text{V}$, $V^- = 0\text{V}$, $V_{\text{CM}} = V^+/2$, $V_O = V^+/2$ and $R_L > 1\text{M}\Omega$. **Boldface** limits apply at the temperature extremes.

Symbol	Parameter	Conditions	Typ (Note 5)	Units
SR	Slew Rate	(Note 7)	5.25	V/ μs min
GBW	Gain-Bandwidth Product		10.0	MHz
Φ_m	Phase Margin		72	Deg
G_m	Gain Margin		-11	dB
e_n	Input-Related Voltage Noise	$f = 1\text{kHz}$	8.5	$\frac{\text{nV}}{\sqrt{\text{Hz}}}$
i_n	Input-Referred Current Noise	$f = 1\text{kHz}$	0.2	$\frac{\text{pA}}{\sqrt{\text{Hz}}}$
THD	Total Harmonic Distortion	$f = 1\text{kHz}$, $A_V = 1$ $R_L = 600\Omega$, $V_O = 1\text{V}_{\text{PP}}$	0.001	%

Note 1: Absolute Maximum Ratings indicate limits beyond which damage to the device may occur. Operating Ratings indicate conditions for which the device is intended to be functional, but specific performance is not guaranteed. For guaranteed specifications and the test conditions, see the Electrical Characteristics.

Note 2: Human body model, 1.5 k Ω in series with 100 pF. Machine model, 200 Ω in series with 100 pF.

Note 3: Applies to both single-supply and split-supply operation. Continuous short circuit operation at elevated ambient temperature can result in exceeding the maximum allowed junction temperature of 150°C. Output currents in excess of 30 mA over long term may adversely affect reliability.

Note 4: The maximum power dissipation is a function of $T_{J(\text{max})}$, θ_{JA} , and T_A . The maximum allowable power dissipation at any ambient temperature is $P_D = (T_{J(\text{max})} - T_A) / \theta_{JA}$. All numbers apply for packages soldered directly into a PC board.

Note 5: Typical Values represent the most likely parametric norm.

Note 6: All limits are guaranteed by testing or statistical analysis.

Note 7: Connected as voltage follower with 1V step input. Number specified is the slower of the positive and negative slew rate.

Typical Performance characteristics

Supply Current vs. Supply Voltage (LMV721)

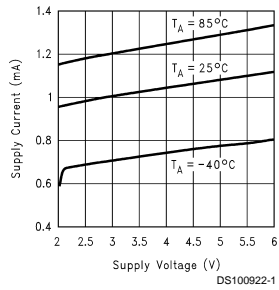

Sourcing Current vs. Output Voltage ($V_S=2.2\text{V}$)

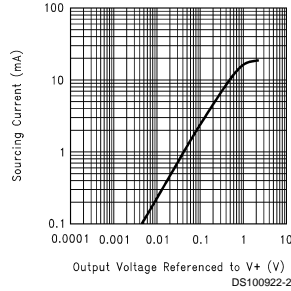

Sourcing Current vs. Output Voltage ($V_S=5\text{V}$)

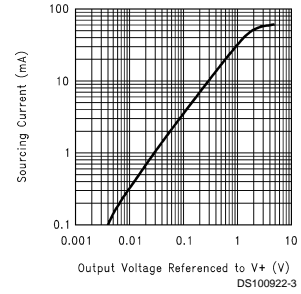

Sinking Current vs. Output Voltage ($V_S=2.2\text{V}$)

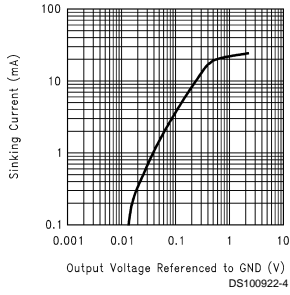

Sinking Current vs. Output Voltage ($V_S=5\text{V}$)

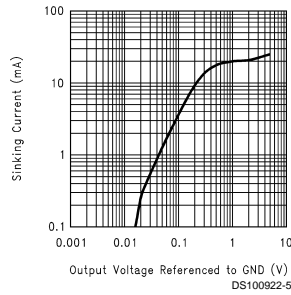

Output Voltage Swing vs. Supply Voltage ($R_L=600\Omega$)

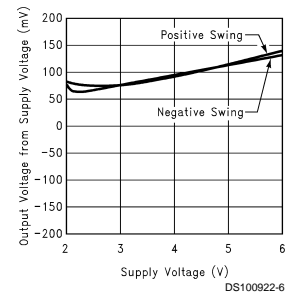

Output Voltage Swing vs. Supply Voltage ($R_L=2\text{k}\Omega$)

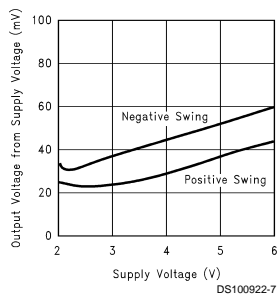

Input Offset Voltage vs. Input Common-Mode Voltage Range ($V_S=2.2\text{V}$)

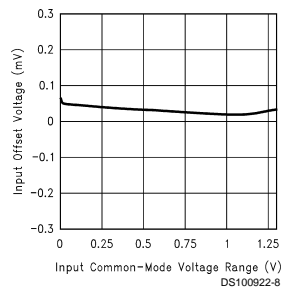

Input Offset Voltage vs. Input Common-Mode Voltage Range ($V_S=5\text{V}$)

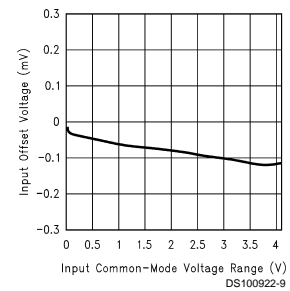

Typical Performance characteristics (Continued)

Input Offset Voltage vs. Supply Voltage ($V_{CM} = V^*/2$)

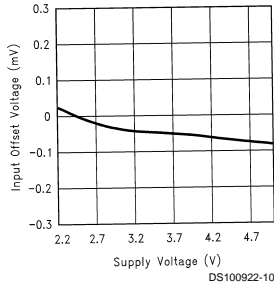

Input Voltage vs. Output Voltage ($V_S = 2.2V, R_L = 2k\Omega$)

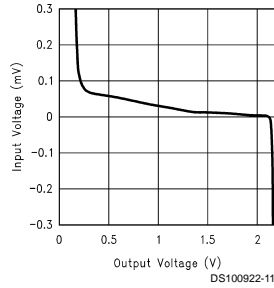

Input Voltage vs. Output Voltage ($V_S = 5V, R_L = 2k\Omega$)

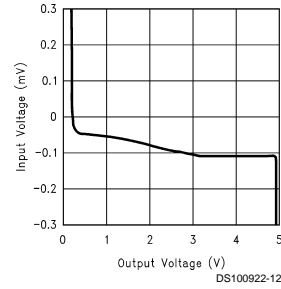

Input Voltage Noise vs. Frequency

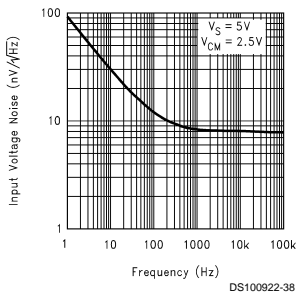

Input Current Noise vs. Frequency

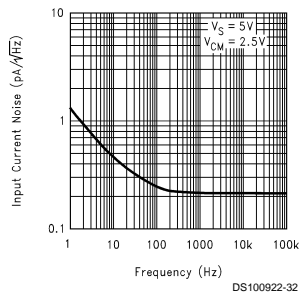

+PSRR vs. Frequency

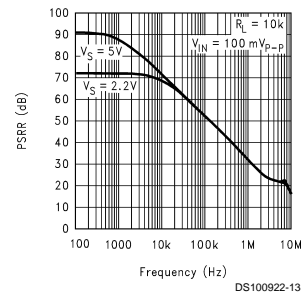

-PSRR vs. Frequency

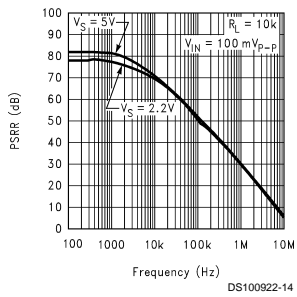

CMRR vs. Frequency

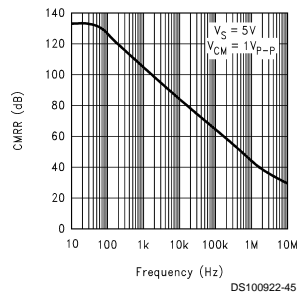

Gain and Phase Margin vs. Frequency ($V_S = 2.2V, R_L = 600\Omega$)

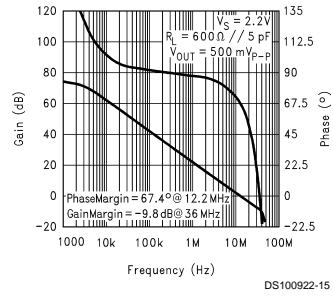

Typical Performance characteristics (Continued)

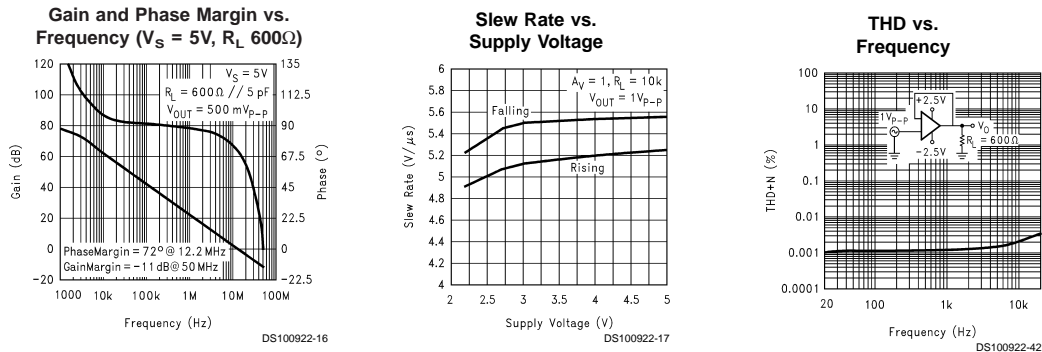

Application Notes

1.0 Benefits of the LMV721/722 Size.

The small footprints of the LMV721/722 packages save space on printed circuit boards, and enable the design of smaller electronic products, such as cellular phones, pagers, or other portable systems. The low profile of the LMV721/722 make them possible to use in PCMCIA type III cards.

Signal Integrity. Signals can pick up noise between the signal source and the amplifier. By using a physically smaller amplifier package, the LMV721/722 can be placed closer to the signal source, reducing noise pickup and increasing signal integrity.

Simplified Board Layout. These products help you to avoid using long pc traces in your pc board layout. This means that no additional components, such as capacitors and resistors, are needed to filter out the unwanted signals due to the interference between the long pc traces.

Low Supply Current. These devices will help you to maximize battery life. They are ideal for battery powered systems.

Low Supply Voltage. National provides guaranteed performance at 2.2V and 5V. These guarantees ensure operation throughout the battery lifetime.

Rail-to-Rail Output. Rail-to-rail output swing provides maximum possible dynamic range at the output. This is particularly important when operating on low supply voltages.

Input Includes Ground. Allows direct sensing near GND in single supply operation.

Protection should be provided to prevent the input voltages from going negative more than $-0.3V$ (at $25^{\circ}C$). An input clamp diode with a resistor to the IC input terminal can be used.

2.0 Capacitive Load Tolerance

The LMV721/722 can directly drive 4700pF in unity-gain without oscillation. The unity-gain follower is the most sensitive configuration to capacitive loading. Direct capacitive loading reduces the phase margin of amplifiers. The combination of the amplifier's output impedance and the capacitive load induces phase lag. This results in either an underdamped pulse response or oscillation. To drive a heavier capacitive load, circuit in *Figure 1* can be used.

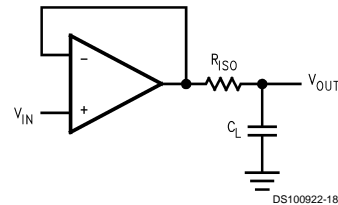

FIGURE 1. Indirectly Driving A capacitive Load Using Resistive Isolation

In *Figure 1*, the isolation resistor R_{ISO} and the load capacitor C_L form a pole to increase stability by adding more phase margin to the overall system. The desired performance depends on the value of R_{ISO} . The bigger the R_{ISO} resistor value, the more stable V_{OUT} will be. *Figure 2* is an output waveform of *Figure 1* using $100k\Omega$ for R_{ISO} and $2000\mu F$ for C_L .

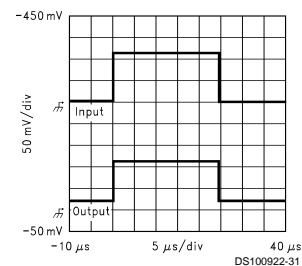

FIGURE 2. Pulse Response of the LMV721 Circuit in Figure 1

The circuit in *Figure 3* is an improvement to the one in *Figure 1* because it provides DC accuracy as well as AC stability. If there were a load resistor in *Figure 1*, the output would be voltage divided by R_{ISO} and the load resistor. Instead, in *Figure 3*, R_F provides the DC accuracy by using feed-forward techniques to connect V_{IN} to R_L . Caution is needed in choosing the value of R_F due to the input bias current of the LMV721/722. C_F and R_{ISO} serve to counteract the loss of phase margin by feeding the high frequency component of the output signal back to the amplifier's inverting input, thereby preserving phase margin in the overall feedback

Application Notes (Continued)

loop. Increased capacitive drive is possible by increasing the value of C_F . This in turn will slow down the pulse response.

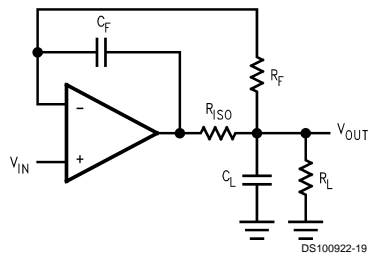

FIGURE 3. Indirectly Driving A Capacitive Load with DC Accuracy

3.0 Input Bias Current Cancellation

The LMV721/722 family has a bipolar input stage. The typical input bias current of LMV721/722 is 260nA with 5V supply. Thus a 100kΩ input resistor will cause 26mV of error voltage. By balancing the resistor values at both inverting and non-inverting inputs, the error caused by the amplifier's input bias current will be reduced. The circuit in *Figure 4* shows how to cancel the error caused by input bias current.

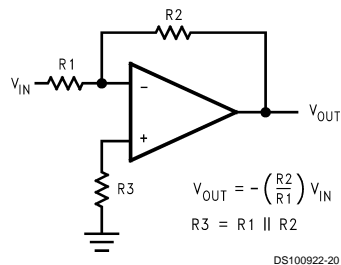
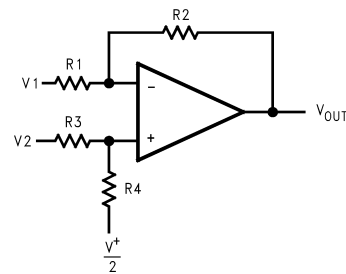

FIGURE 4. Cancelling the Error Caused by Input Bias Current

4.0 Typical Single-Supply Application Circuits

4.1 Difference amplifier

The difference amplifier allows the subtraction of two voltages or, as a special case, the cancellation of a signal common to two inputs. It is useful as a computational amplifier, in making a differential to single-ended conversion or in rejecting a common mode signal.



$$V_{OUT} = \left(\frac{R_1 + R_2}{R_3 + R_4}\right) \frac{R_4}{R_1} V_2 - \frac{R_2}{R_1} V_1 + \left(\frac{R_1 + R_2}{R_3 + R_4}\right) \frac{R_3}{R_1} \cdot \frac{V^+}{2}$$

for $R_1 = R_3$ and $R_2 = R_4$

$$V_{OUT} = \frac{R_2}{R_1} (V_2 - V_1) + \frac{V^+}{2}$$

FIGURE 5. Difference Application

4.2 Instrumentation Circuits

The input impedance of the previous difference amplifier is set by the resistor R_1 , R_2 , R_3 and R_4 . To eliminate the problems of low input impedance, one way is to use a voltage follower ahead of each input as shown in the following two instrumentation amplifiers.

4.2.1 Three-op-amp Instrumentation Amplifier

The LMV721/722 can be used to build a three-op-amp instrumentation amplifier as shown in *Figure 6*

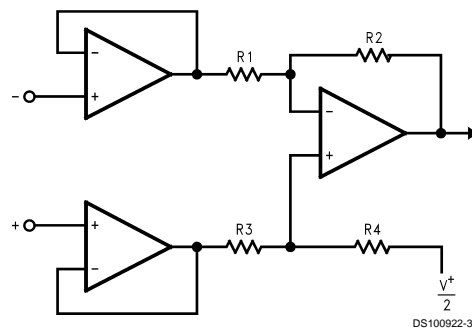

FIGURE 6. Three-op-amp Instrumentation Amplifier

The first stage of this instrumentation amplifier is a differential-input, differential-output amplifier, with two voltage followers. These two voltage followers assure that the input impedance is over 100MΩ. The gain of this instrumentation amplifier is set by the ratio of R_2/R_1 . R_3 should equal R_1 and R_4 equal R_2 . Matching of R_3 to R_1 and R_4 to R_2 affects the CMRR. For good CMRR over temperature, low drift resistors should be used. Making R_4 slightly smaller than R_2 and adding a trim pot equal to twice the difference between R_2 and R_4 will allow the CMRR to be adjusted for optimum.

4.2.2 Two-op-amp Instrumentation Amplifier

A two-op-amp instrumentation amplifier can also be used to make a high-input impedance DC differential amplifier (*Figure 7*). As in the two-op-amp circuit, this instrumentation amplifier requires precise resistor matching for good CMRR. R_4 should equal to R_1 and R_3 should equal R_2 .

Application Notes (Continued)

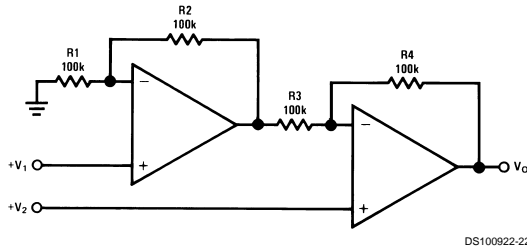

DS100922-22

$$V_O = \left(1 + \frac{R_4}{R_3}\right)(V_2 - V_1), \text{ where } R_1 = R_4 \text{ and } R_2 = R_3$$

$$\text{As shown: } V_O = 2(V_2 - V_1)$$

FIGURE 7. Two-op-amp Instrumentation Amplifier

4.3 Single-Supply Inverting Amplifier

There may be cases where the input signal going into the amplifier is negative. Because the amplifier is operating in single supply voltage, a voltage divider using R_3 and R_4 is implemented to bias the amplifier so the input signal is within the input common-mode voltage range of the amplifier. The capacitor C_1 is placed between the inverting input and resistor R_1 to block the DC signal going into the AC signal source, V_{IN} . The values of R_1 and C_1 affect the cutoff frequency, $f_c = \frac{1}{2\pi R_1 C_1}$.

As a result, the output signal is centered around mid-supply (if the voltage divider provides $V^*/2$ at the non-inverting input). The output can swing to both rails, maximizing the signal-to-noise ratio in a low voltage system.

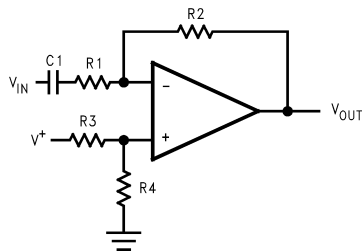

DS100922-23

$$V_{OUT} = -\frac{R_2}{R_1} V_{IN}$$

FIGURE 8. Single-Supply Inverting Amplifier

4.4 Active Filter

4.4.1 Simple Low-Pass Active Filter

The simple low-pass filter is shown in *Figure 9*. Its low-pass frequency gain ($\omega \rightarrow 0$) is defined by $-R_3/R_1$. This allows low-frequency gains other than unity to be obtained. The filter has a -20dB/decade roll-off after its corner frequency f_c . R_2 should be chosen equal to the parallel combination of R_1 and R_3 to minimize error due to bias current. The frequency response of the filter is shown in *Figure 10*.

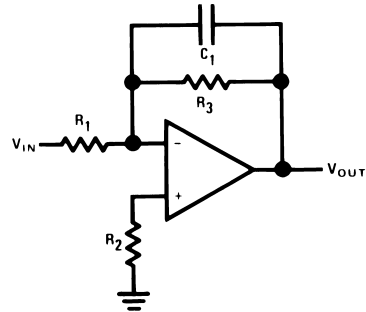

DS100922-24

$$A_L = -\frac{R_3}{R_1}$$

$$f_c = \frac{1}{2\pi R_3 C_1}$$

$$R_2 = R_1 \parallel R_3$$

FIGURE 9. Simple Low-Pass Active Filter

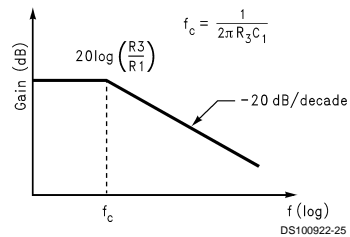

DS100922-25

FIGURE 10. Frequency Response of Simple Low-pass Active Filter in *Figure 9*

Note that the single-op-amp active filters are used in to the applications that require low quality factor, $Q(\leq 10)$, low frequency ($\leq 5\text{KHz}$), and low gain (≤ 10), or a small value for the product of gain times $Q(\leq 100)$. The op amp should have an open loop voltage gain at the highest frequency of interest at least 50 times larger than the gain of the filter at this frequency. In addition, the selected op amp should have a slew rate that meets the following requirement:

$$\text{Slew Rate} \geq 0.5 \times (\omega_H V_{OPP}) \times 10^{-6} \text{V}/\mu\text{sec}$$

Where ω_H is the highest frequency of interest, and V_{OPP} is the output peak-to-peak voltage.

Application Notes (Continued)

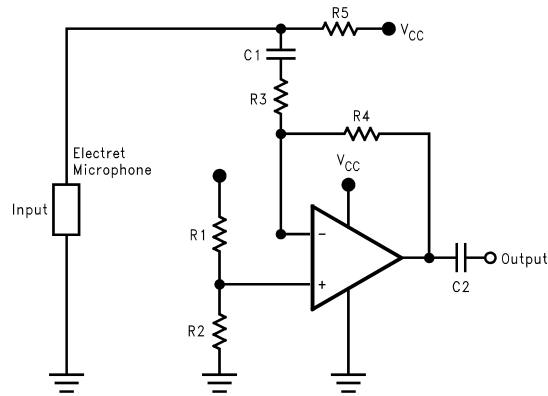

DS100922-44

FIGURE 11. A Battery Powered Microphone Preamplifier

Here is a LMV721 used as a microphone preamplifier. Since the LMV721 is a low noise and low power op amp, it makes it an ideal candidate as a battery powered microphone preamplifier. The LMV721 is connected in an inverting configuration. Resistors, $R_1 = R_2 = 4.7\text{k}\Omega$, sets the reference half way between $V_{CC} = 3\text{V}$ and ground. Thus, this configures the op amp for single supply use. The gain of the preamplifier, which is 50 (34dB), is set by resistors $R_3 = 10\text{k}\Omega$ and $R_4 = 500\text{k}\Omega$. The gain bandwidth product for the LMV721 is 10 MHz. This is sufficient for most audio application since the audio range is typically from 20 Hz to 20kHz. A resistor $R_5 = 5\text{k}\Omega$ is used to bias the electret microphone. Capacitors $C_1 = C_2 = 4.7\mu\text{F}$ placed at the input and output of the op amp to block out the DC voltage offset.

Physical Dimensions inches (millimeters) unless otherwise noted

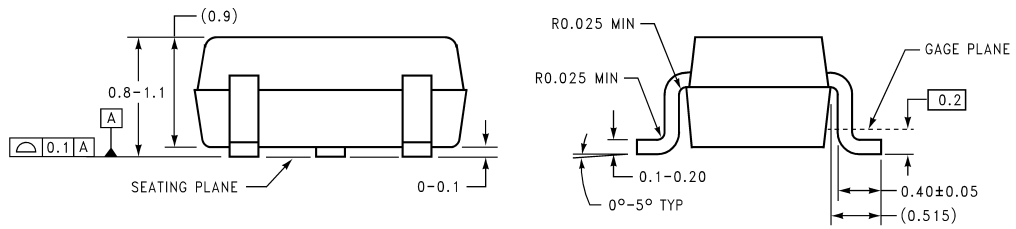
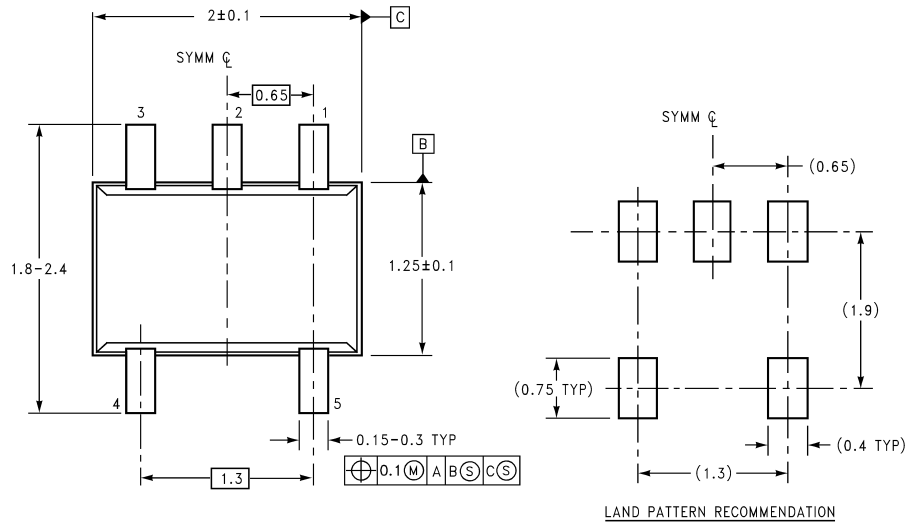

DIMENSIONS ARE IN MILLIMETERS

MAA05A (REV B)

SC70-5
Order Number LMV721M7 or LMV721M7X
NS Package Number MAA05A

Physical Dimensions inches (millimeters) unless otherwise noted (Continued)

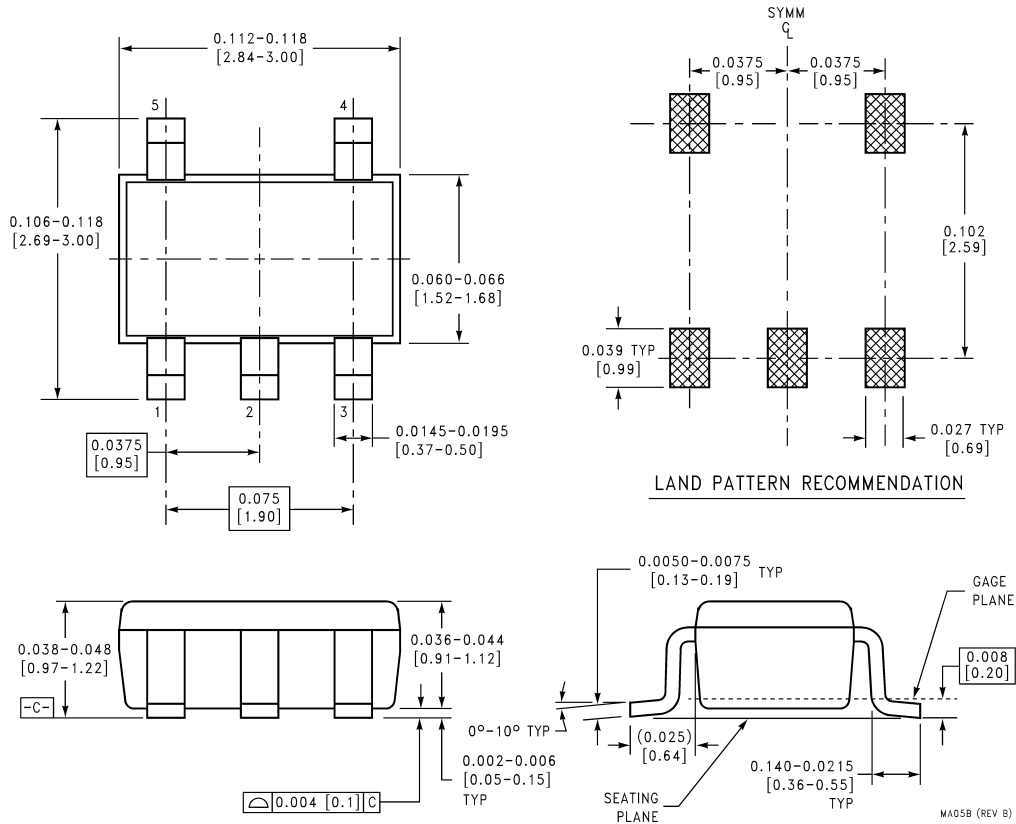

SOT 23-5
Order Number LMV721M5 or LMV721M5X
NS Package Number MA05B

MA05B (REV B)

Physical Dimensions inches (millimeters) unless otherwise noted (Continued)

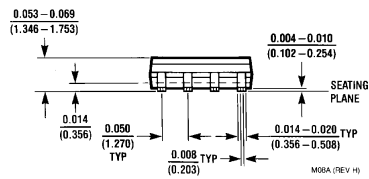
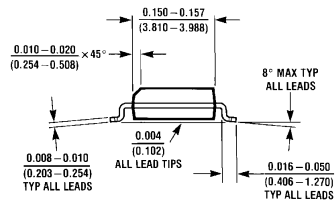
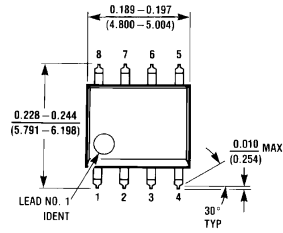

8-Pin Small Outline
Order Number LMV722M or LMV722MX
NS Package Number M08A

Physical Dimensions inches (millimeters) unless otherwise noted (Continued)

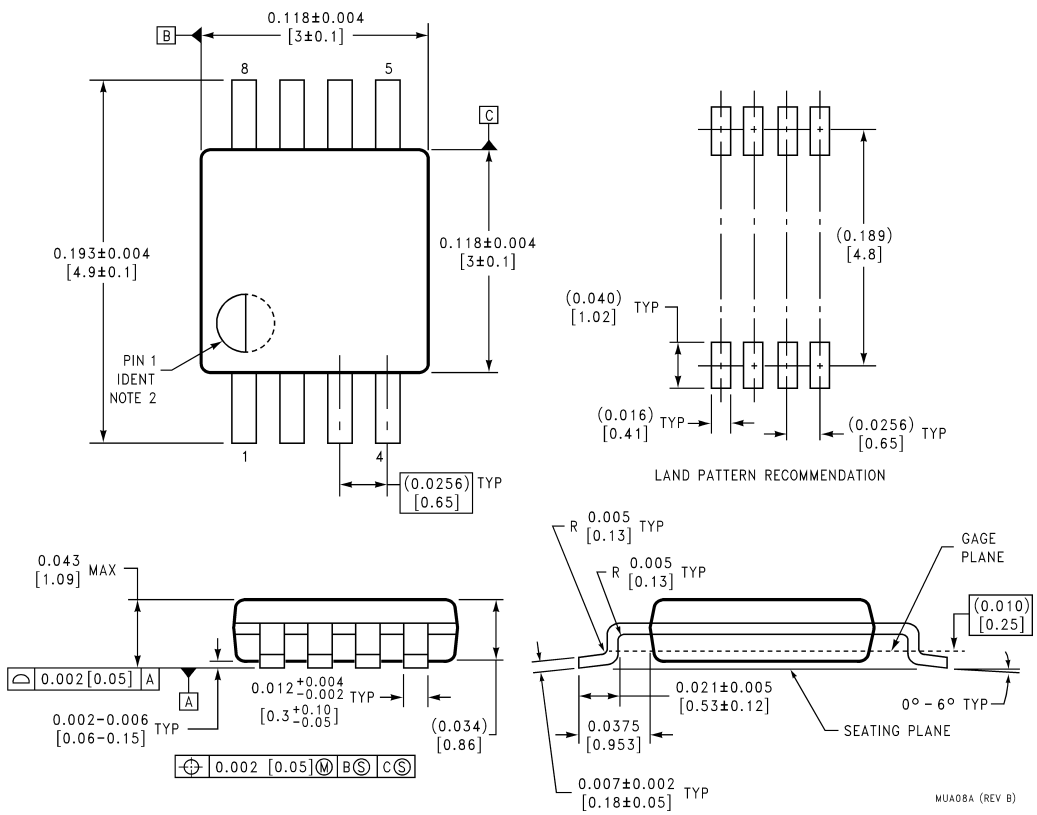

8-Pin MSOP
Order Number LMV722MM or LMV722MMX
NS Package Number MUA08A

LIFE SUPPORT POLICY

NATIONAL'S PRODUCTS ARE NOT AUTHORIZED FOR USE AS CRITICAL COMPONENTS IN LIFE SUPPORT DEVICES OR SYSTEMS WITHOUT THE EXPRESS WRITTEN APPROVAL OF THE PRESIDENT AND GENERAL COUNSEL OF NATIONAL SEMICONDUCTOR CORPORATION. As used herein:

1. Life support devices or systems are devices or systems which, (a) are intended for surgical implant into the body, or (b) support or sustain life, and whose failure to perform when properly used in accordance with instructions for use provided in the labeling, can be reasonably expected to result in a significant injury to the user.
2. A critical component is any component of a life support device or system whose failure to perform can be reasonably expected to cause the failure of the life support device or system, or to affect its safety or effectiveness.

 <p>National Semiconductor Corporation Americas Tel: 1-800-272-9959 Fax: 1-800-737-7018 Email: support@nsc.com www.national.com</p>	<p>National Semiconductor Europe Fax: +49 (0) 1 80-530 85 86 Email: europe.support@nsc.com Deutsch Tel: +49 (0) 1 80-530 85 85 English Tel: +49 (0) 1 80-532 78 32 Français Tel: +49 (0) 1 80-532 93 58 Italiano Tel: +49 (0) 1 80-534 16 80</p>	<p>National Semiconductor Asia Pacific Customer Response Group Tel: 65-2544466 Fax: 65-2504466 Email: sea.support@nsc.com</p>	<p>National Semiconductor Japan Ltd. Tel: 81-3-5639-7560 Fax: 81-3-5639-7507</p>
--	---	---	---

National does not assume any responsibility for use of any circuitry described, no circuit patent licenses are implied and National reserves the right at any time without notice to change said circuitry and specifications.