

DESCRIPTIONS

The IP9004A is a 5-CH motor driver for CD-P/VCDP/ DVDP systems. It is composed of 4-CH BTL driver and 1-CH forward/reverse controlled DC motor driver.



FEATURES

- 4-CH BTL(Balanced Transformerless) driver
- 1-CH forward/reverse controlled DC motor driver
- Built-in TSD (thermal shut down) circuit
- Built-in mute circuit
- Built-in MSC (motor speed control) circuit
- Built-in 5V regulator with an external PNP TR
- Operating supply voltage (4.5V~13.2V)

ORDER INFORMATION

Device	Package	Operating Temp
IP9004A	32SSOPH	-35°C ~ +85°C
IP9004AL	32SSOPH	-35°C ~ +85°C
IP9004A-TF	32SSOPH	-35°C ~ +85°C
IP9004AL-TF	32SSOPH	-35°C ~ +85°C

- L : Lead Free products
- TF : Tape & Reel packing
- L-TF : Lead Free and Tape & Reel packing

PIN CONNECTIONS

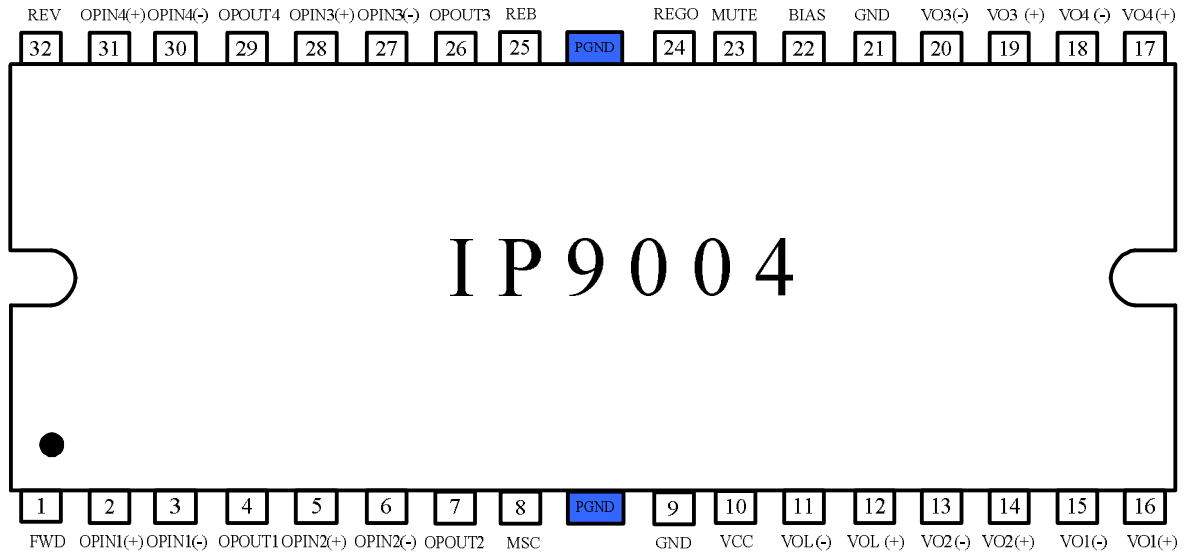

PIN DESCRIPTIONS

NO	SYMBOL	I/O	DESCRIPTION	NO	SYMBOL	I/O	DESCRIPTION
1	FWD	I	Forward Input	17	Vo4(+)	O	CH4 OUPUT(-)
2	OPIN1(+)	I	CH1 OP-AMP Input (+)	18	Vo4(-)	O	CH4 OUPUT(+)
3	OPIN1(-)	I	CH1 OP-AMP Input (-)	19	Vo3(+)	O	CH3 OUPUT(-)
4	OPOUT1	O	CH1 OP-AMP Output	20	Vo3(-)	O	CH3 OUPUT(+)
5	OPIN2(+)	I	CH2 OP-AMP Input (+)	21	GND	-	GROUND
6	OPIN2(-)	I	CH2 OP-AMP Input (-)	22	BIAS	I	BIAS
7	OPOUT2	O	CH2 OP-AMP Output	23	MUTE	I	MUTE
8	MSC	I	MOTOR SPEED CONTROL	24	REGO	O	REGULATOR OUTPUT
9	GND	-	GROUND	25	REB	O	REGULATOR BASE
10	Vcc	I	Supply Voltage	26	OPOUT3	O	CH3 OP-AMP Output
11	VoL(-)	O	LOADING OUPUT(-)	27	OPIN3(-)	I	CH3 OP-AMP Input (-)
12	VoL(+)	O	LOADING OUPUT(+)	28	OPIN3(+)	I	CH3 OP-AMP Input (+)
13	Vo2(-)	O	CH2 OUPUT(-)	29	OPOUT4	O	CH4 OP-AMP Output
14	Vo2(+)	O	CH2 OUPUT(+)	30	OPIN4(-)	I	CH4 OP-AMP Input (-)
15	Vo1(-)	O	CH1 OUPUT(-)	31	OPIN4(+)	I	CH4 OP-AMP Input (+)
16	Vo1(+)	O	CH1 OUPUT(+)	32	REV	I	Reverse Input

ABSOLUTE MAXIMUM RATINGS

CHARACTERISTICS	SYMBOL	VALUE	UNIT
Maximum supply voltage	VCCmax	15	V
Power dissipation	Pd	1.8 *	W
Operating temperature	Topr	-35 ~ +85	°C
Storage temperature	Tstg	-55 ~ 150	°C

Note>

1. When mounted on 50mm X 50mm X 1mm PCB (Phenolic resin material).
2. Power dissipation reduces 14.4 mW/°C for using above Ta=25°C
3. Do not exceed Pd and SOA.

POWER DISSIPATION CURVE

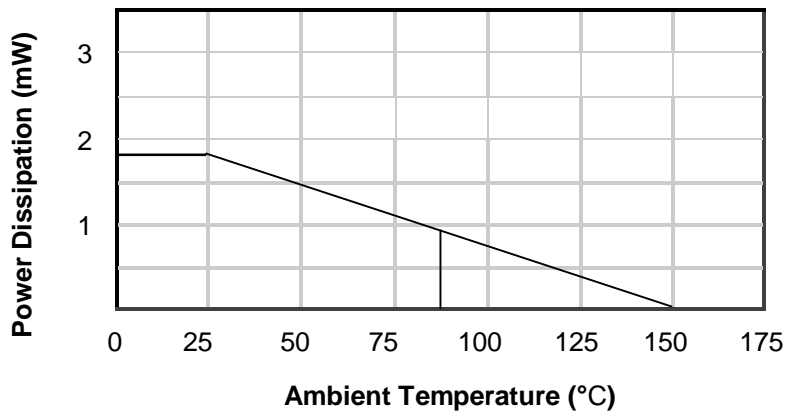

RECOMMENDED OPERATING CONDITIONS

CHARACTERISTICS	SYMBOL	VALUE	UNIT
Supply Voltage	VCC	*4.5 ~ 13.2	V

* Supply voltage **must be larger than** 6.0V, when 5.0V regulator **is** used.

ELECTRICAL CHARACTERISTICS

(VCC=8V, RL = 12ohm, Ta = 25°C unless otherwise specified.)

CHARACTERISTICS	SYMBOL	CONDITIONS	MIN	TYP	MAX	UNIT
Quiescent circuit current	Icc	No Load	-	24	-	mA
Mute on voltage	Vmon	Pin23=Variable	-	-	0.5	V
Mute off voltage	Vmoff	Pin23=Variable	1.5	-	-	V
[BTL DRIVER PART]						
Output offset voltage	Voo		-80	0	80	mV
Maximum output voltage	Vom	RL=12ohm	4.7	5.3	-	V
Voltage gain	Gvc	Vin=0.1Vrms, f=1Khz	14	16	18	dB
Ripple rejection ratio	RR	Vin=0.1Vrms, f=120Hz	50	60	-	dB
Slew rate	SR	Vout=4Vp-p, square	-	1.5	-	V/us
[INPUT OPAMP CIRCUIT]						
Common Mode Input Range	VICM	-	0.5	-	6.8	V
High level output voltage	VOHOP	-	7.0	-	-	V
Low level output voltage	VOLOP	-	-	-	0.5	V
Output sink current	ISINK	RVcc=50ohm	1	-	-	mA
Output source current	ISOU	RGND=50ohm	1	-	-	mA
[LOADING DRIVER PART]						
Input high level voltage	Vih	-	2	-	-	V
Input high level voltage	Vil	-	-	-	0.5	V
Output voltage	Vo	RL=45ohm, Pin8=open	5.4	6.0	-	V
Output voltage regulation	Vo	RL=45ohm, $\Delta V_{Pin8}=1.0 V$	2	2.5	3	V
Output offset voltage 1	ΔV_{oo1}	Pin1, Pin32=5V	-80	-	+80	mV
Output offset voltage 2	Voo2	Pin1, Pin32=0V	-80	-	+80	mV

ELECTRICAL CHARACTERISTICS

(VCC=8V, RL = 8ohm, Ta = 25°C unless otherwise specified.)

CHARACTERISTICS	SYMBOL	CONDITIONS	MIN	TYP	MAX	UNIT
[REGULATOR PART]						
Output voltage	VREG	IL=100mA	4.7	5.0	5.3	V
Load Regulation	ΔV_{om}	IL=0->200mA	-50	0	50	mV
Line Regulation	ΔV_{cc}	Vcc=6->10V,IL=100mA	-60	0	60	mV

TYPICAL APPLICATION CIRCUIT

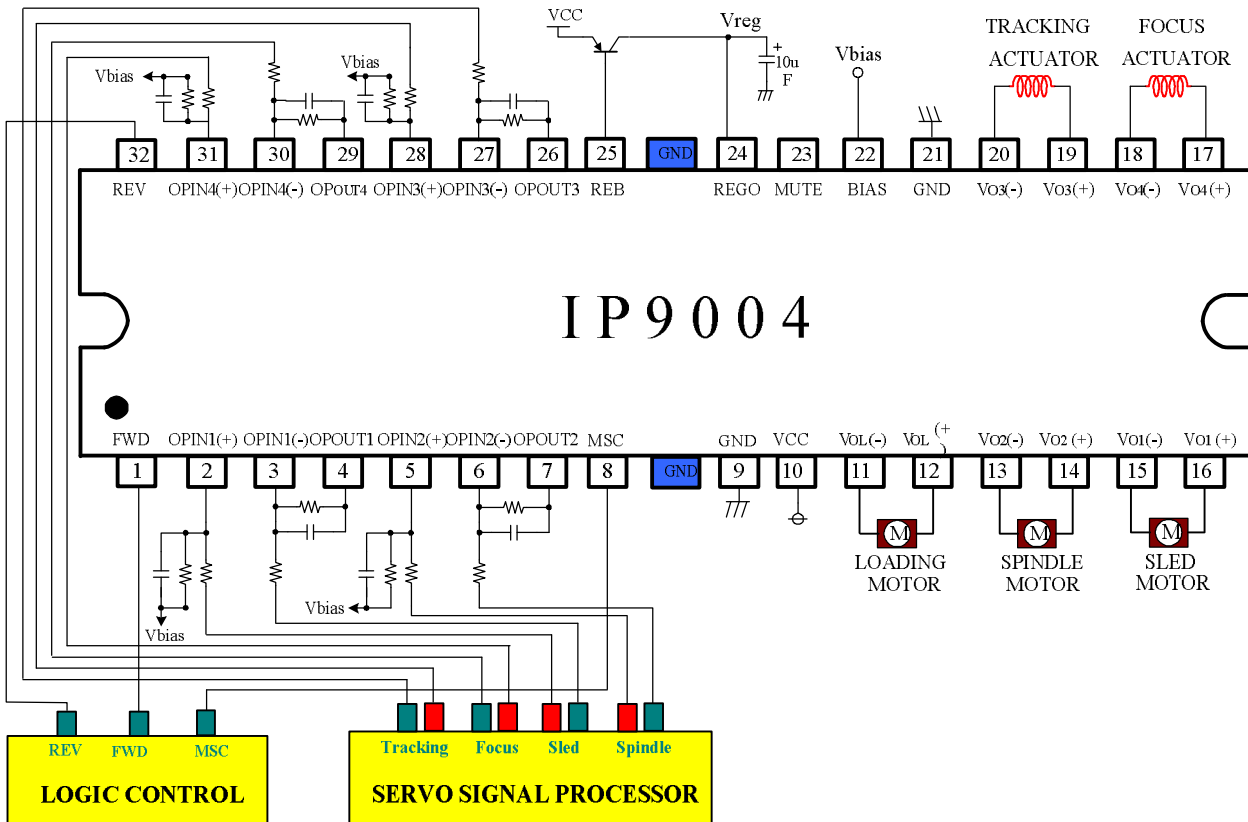

ELECTRICAL CHARACTERISTICS CURVES

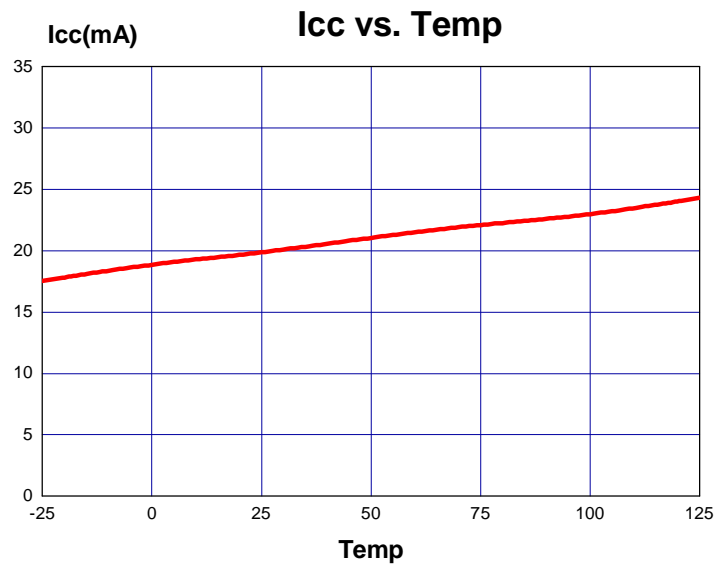
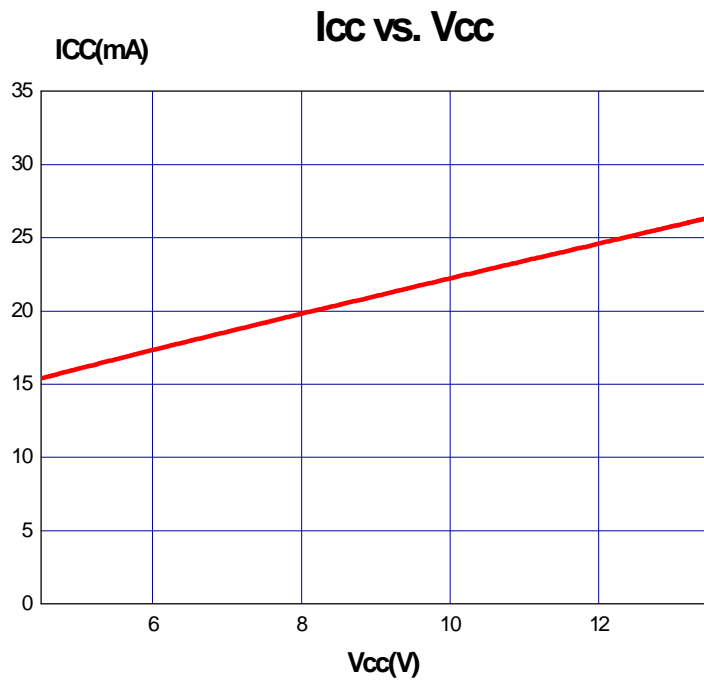

ELECTRICAL CHARACTERISTICS CURVES (Continued)

Gvs vs. Vcc (CH3)

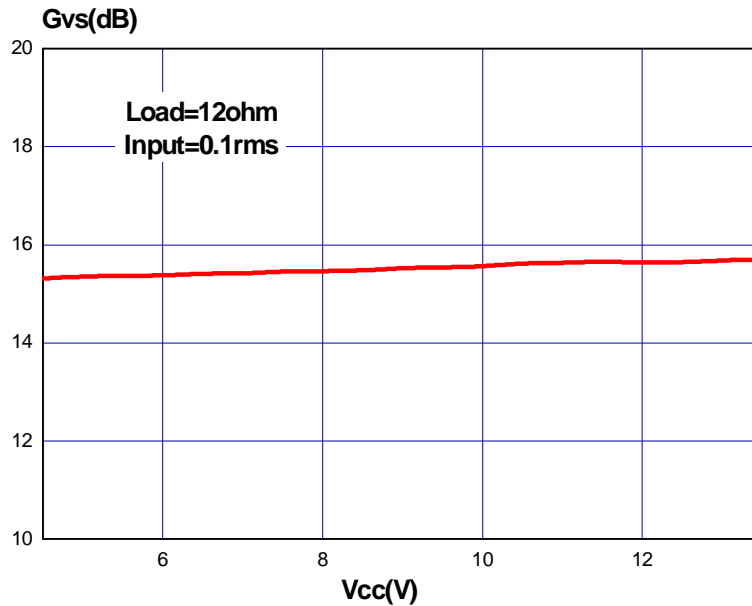

Vom vs. Temp (CH3)

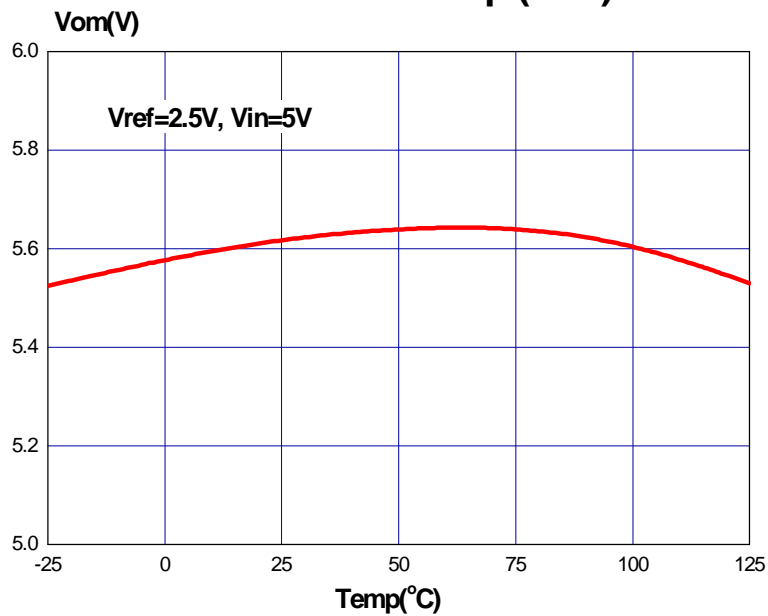

ELECTRICAL CHARACTERISTICS CURVES (Continued)

Vo1 vs. Vm_{sc} (loading)

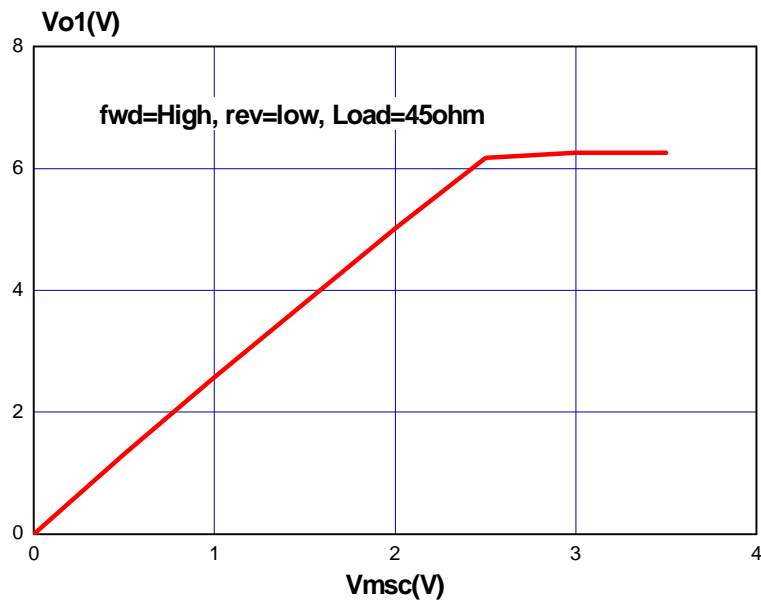

Vo1 vs. Vm_{sc}(loading)

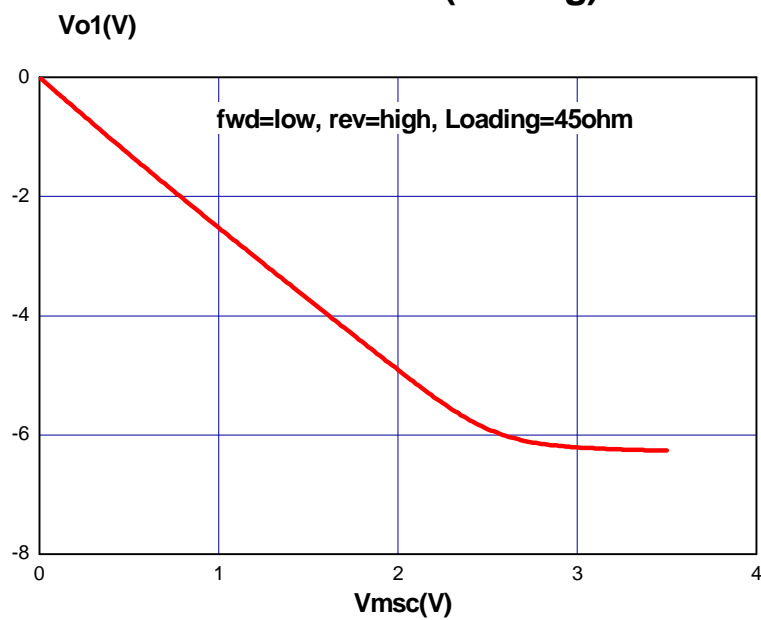

ELECTRICAL CHARACTERISTICS CURVES (Continued)

Vreg vs. Vcc

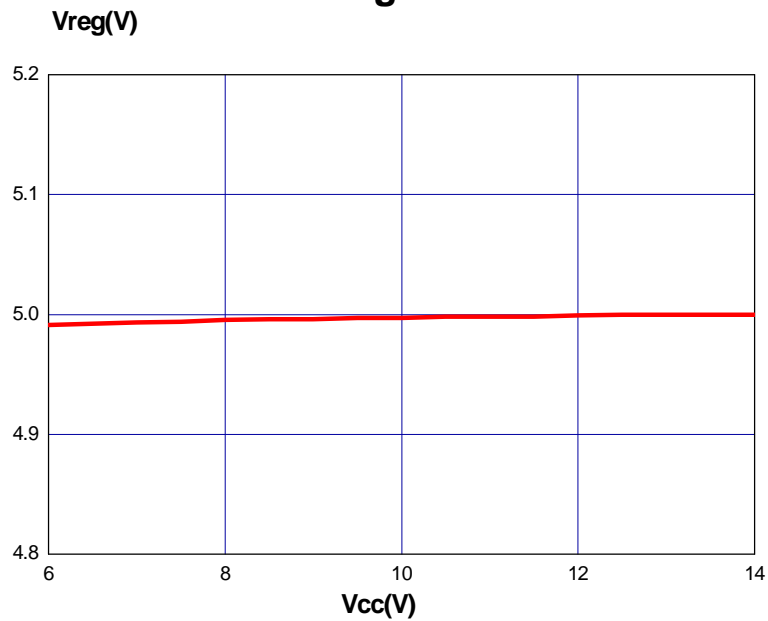

Vreg vs. Iload

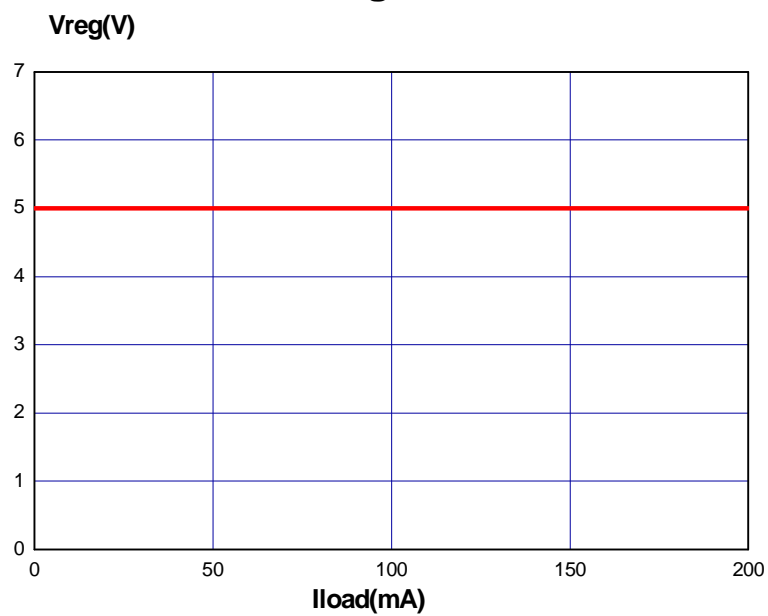

ELECTRICAL CHARACTERISTICS CURVES (Continued)

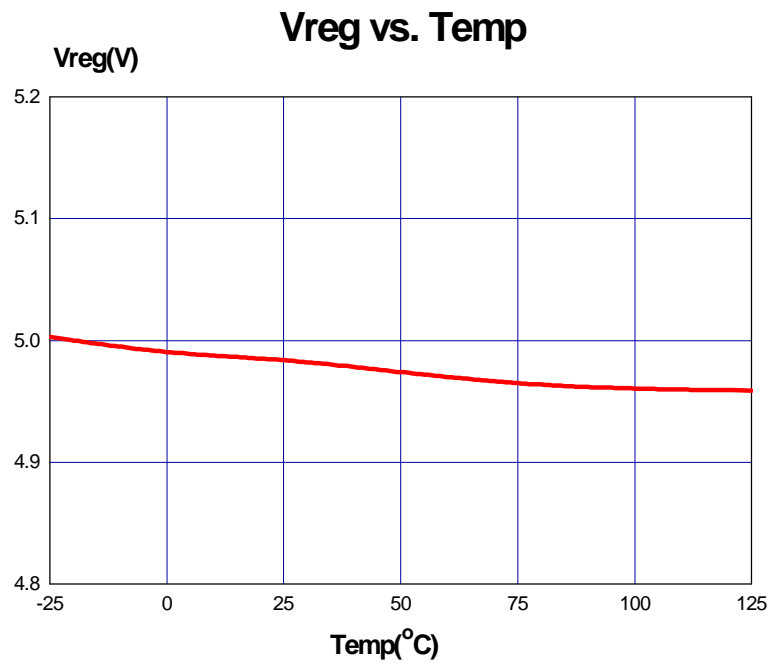

PACKAGE DIMENSION

[32SSOPH]

