

HA1398

Dual 5.8W Audio Power Amplifiers

FEATURES

- Very low distortion in the wide range of frequency; Total harmonic distortion is lower than 0.5% (typ. 0.2%) when output power in from 0.1 W to 3 W and frequency range is from 100 Hz to 10 kHz.
- Easy to mount a chassis by heat-sink, due to the single-in-line package with no electrical isolation.
- Overvoltage handling capability up to 50 volts for 200 ms pulse duration.
- Thermal shut-down circuit included.
- Less number of external components.

Absolute Maximum Ratings ($T_a = 25^\circ\text{C}$)

Operating Supply Voltage	18 V
DC Supply Voltage (30 sec)	26 V
Peak Supply Voltage (Note)	50 V
Output Current	4A per channel
Power Dissipation	15W per package
Thermal Resistance (Junction-Case)	3°C/W
Junction Temperature	150°C
Operating Temperature Range	-20°C to 70°C
Storage Temperature Range	-55°C to 125°C

Note: Pulse width = 200 m sec, $T_{\text{rise}} \geq 1$ m sec

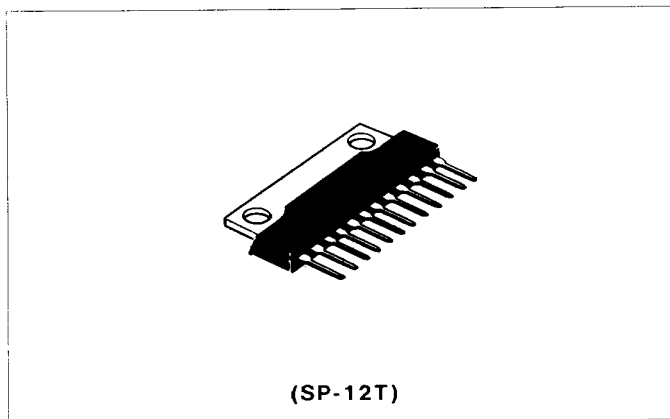

TYPICAL APPLICATION

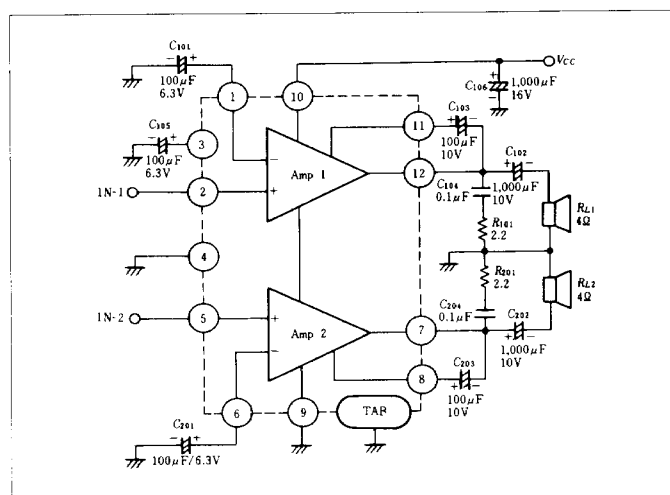

ELECTRICAL CHARACTERISTICS ($T_a = 25^\circ\text{C}$, $V_{CC} = 13.2\text{V}$, $f = 1\text{kHz}$, $R_L = 4\Omega$, One-half Operation)

Item	Symbol	Test Condition	min.	typ.	max.	Unit	
Quiescent Current	I_Q	$V_{i,n} = 0$	40	80	160	mA	
Input Bias Voltage	V_B	$V_{i,n} = 0$	—	—	40	mV	
Voltage Gain	G_V	$V_{i,n} = 2.45\text{mV}$	45	47	49	dB	
Difference of Voltage Gain	ΔG_V	$V_{i,n} = 2.45\text{mV}$	—	—	± 1.5	dB	
Output Power Per Channel	P_{out}	$R_L = 4\Omega$ $THD = 10\%$	$V_{CC} = 13.2\text{V}$	5.0	5.8	—	W
			$V_{CC} = 14.4\text{V}$	—	7.0	—	
Total Harmonic Distortion	THD	$P_{out} = 1.5\text{W}$	—	0.08	0.5	%	
Noise Output	WBN	$R_s = 10\text{k}\Omega$, $BW = 20\text{Hz}$ to 20kHz	—	0.4	1.0	mV	
Supply Voltage Rejection Ratio	SVR	$R_s = 600\Omega$, $f = 500\text{Hz}$	36	46	—	dB	
Input Resistance	$R_{i,n}$	$f = 1\text{kHz}$	—	30	—	$\text{k}\Omega$	
Roll-off Frequency	f_L	$G_V = -3\text{dB}$ from $f = 1\text{kHz}$ Ref.	Low	—	40	—	Hz
	f_H		High	—	60	—	kHz
Cross-talk	CT	$f = 500\text{Hz}$, $R_s = 600\Omega$	40	60	—	dB	

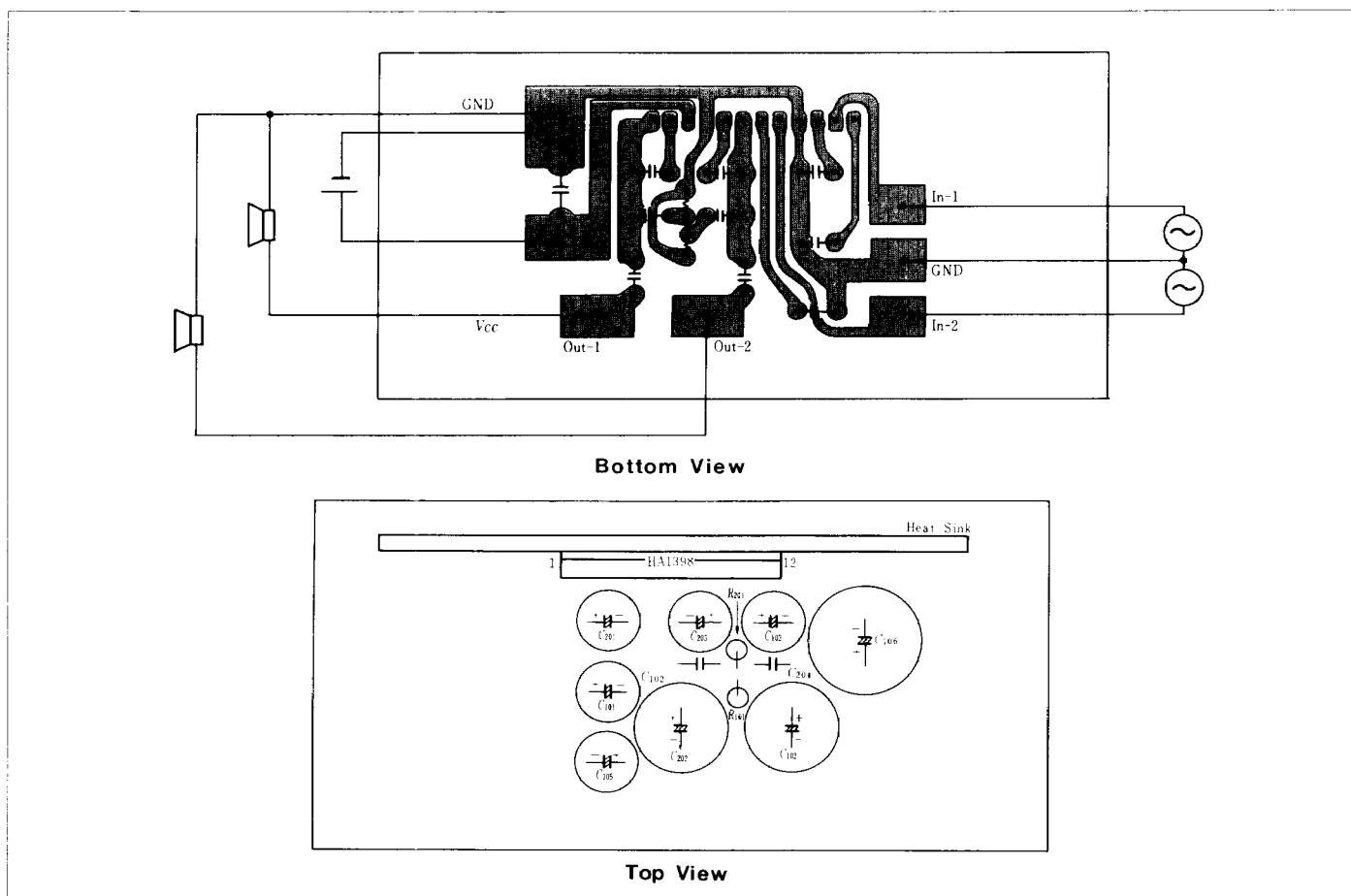

■ EXTERNAL COMPONENTS

Parts No.	Recommended Value	Purpose	Larger than recommended value	Smaller than recommended value
C_{101}, C_{201}	100 μ F	Inverting DC decoupling		Higher low frequency rolloff
C_{102}, C_{202}	1000 μ F	Output coupling to load	Danger of burn-out	Higher low frequency rolloff
C_{103}, C_{203}	100 μ F	Boot stop	Danger of burn-out at load dump surge	Smaller power bandwidth
C_{104}, C_{204}	0.1 μ F	Frequency stability	Increase of drain current at high frequency	Danger of oscillation
C_{105}	100 μ F	Ripple rejection		Pop sound at switch-on
C_{106}	1000 μ F	Supply bypassing		Danger of oscillation
R_{101}, R_{201}	2.2 Ω	Frequency stability	Danger of oscillation	Danger of oscillation

TOTAL HARMONIC DISTORTION VS. OUTPUT POWER

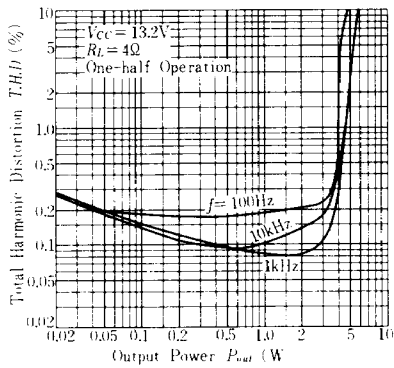

TOTAL HARMONIC DISTORTION VS. FREQUENCY

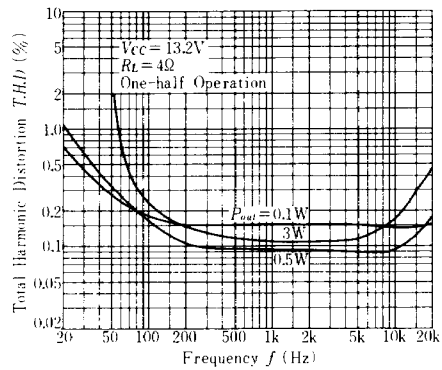

OUTPUT POWER VS. SUPPLY VOLTAGE

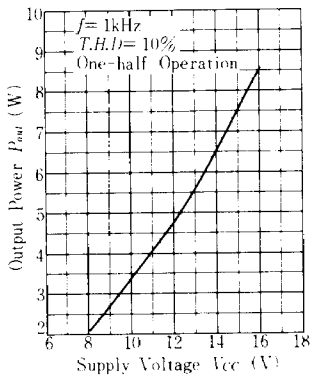

FREQUENCY RESPONSE OF VOLTAGE GAIN

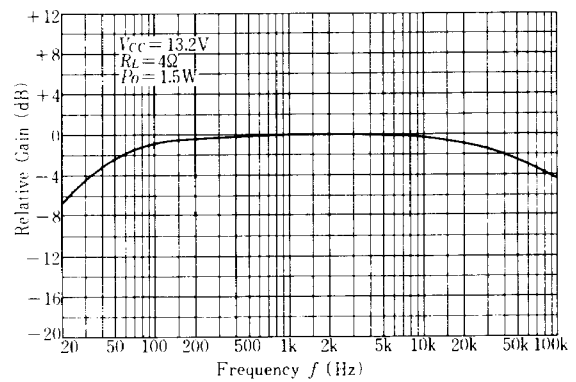

OUTPUT NOISE VOLTAGE VS. SIGNAL SOURCE RESISTANCE

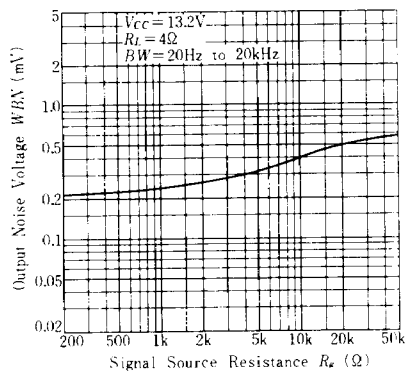

SUPPLY VOLTAGE REJECTION RATIO VS. FREQUENCY

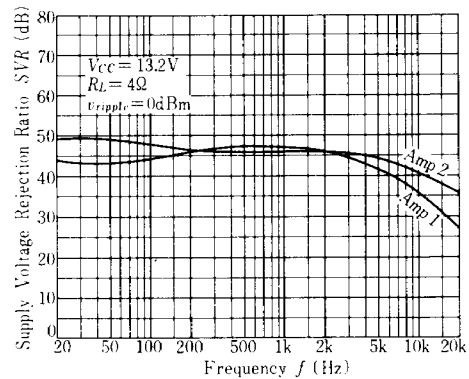

CROSS-TALK VS. FREQUENCY

