

CMOS Presettable Up/Down Counter

Binary or BCD-Decade

High-Voltage Types (20-Volt Rating)

■ CD4029B consists of a four-stage binary or BCD-decade up/down counter with provisions for look-ahead carry in both counting modes. The inputs consist of a single **CLOCK**, **CARRY-IN (CLOCK ENABLE)**, **BINARY/DECADE**, **UP/DOWN**, **PRESET ENABLE**, and four individual **JAM** signals. **Q1, Q2, Q3, Q4** and a **CARRY OUT** signal are provided as outputs.

A high **PRESET ENABLE** signal allows information on the **JAM INPUTS** to preset the counter to any state asynchronously with the clock. A low on each **JAM** line, when the **PRESET-ENABLE** signal is high, resets the counter to its zero count. The counter is advanced one count at the positive transition of the clock when the **CARRY-IN** and **PRESET ENABLE** signals are low. Advancement is inhibited when the **CARRY-IN** or **PRESET ENABLE** signals are high. The **CARRY-OUT** signal is normally high and goes low when the counter reaches its maximum count in the **UP** mode or the minimum count in the **DOWN** mode provided the **CARRY-IN** signal is low. The **CARRY-IN** signal in the low state can thus be considered a **CLOCK ENABLE**. The **CARRY-IN** terminal must be connected to **V_{SS}** when not in use.

Binary counting is accomplished when the **BINARY/DECADE** input is high; the counter counts in the decade mode when the **BINARY/DECADE** input is low. The counter counts up when the **UP/DOWN** input is high, and down when the **UP/DOWN** input is low. Multiple packages can be connected in either a parallel-clocking or a ripple-clocking arrangement as shown in Fig. 17.

Parallel clocking provides synchronous control and hence faster response from all counting outputs. Ripple-clocking allows for longer clock input rise and fall times.

The CD4029B-series types are supplied in 16-lead ceramic dual-in-line plastic packages (E suffix), and in chip form (H suffix).

CD4029B Terminal Diagram

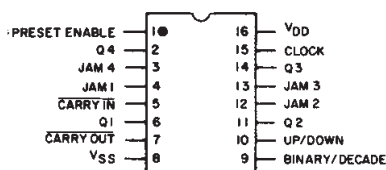

92CS-24472R1

CD4029B Types

Features:

- Medium-speed operation . . . 8 MHz (typ.)
@ $C_L = 50$ pF and $V_{DD} - V_{SS} = 10$ V
- Multi-package parallel clocking for synchronous high speed output response or ripple clocking for slow clock input rise and fall times
- "Preset Enable" and individual "Jam" inputs provided
- Binary or decade up/down counting
- BCD outputs in decade mode
- 100% tested for quiescent current at 20 V
- 5-V, 10-V, and 15-V parametric ratings
- Standardized, symmetrical output characteristics
- Maximum input current of 1 μ A at 18 V over full package-temperature range; 100 nA at 18 V and 25°C
- Noise margin (over full package-temperature range)
 - 1 V at $V_{DD} = 5$ V
 - 2 V at $V_{DD} = 10$ V
 - 2.5 V at $V_{DD} = 15$ V
- Meets all requirements of JEDEC Tentative Standard No. 13B, "Standard Specifications for Description of 'B' Series CMOS Devices"

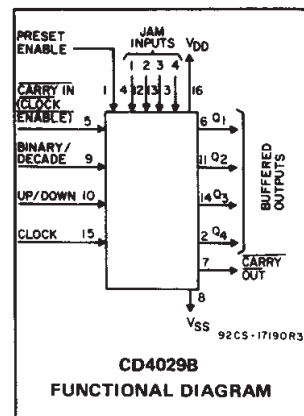

CD4029B
FUNCTIONAL DIAGRAM

Applications:

- Programmable binary and decade counting/frequency synthesizers-BCD output
- Analog to digital and digital to analog conversion
- Up/Down binary counting
- Magnitude and sign generation
- Up/Down decade counting
- Difference counting

RECOMMENDED OPERATING CONDITIONS at $T_A = 25^\circ\text{C}$, Except as Noted. For maximum reliability, nominal operating conditions should be selected so that operation is always within the following ranges:

CHARACTERISTIC	V_{DD} (V)	LIMITS		UNITS
		Min.	Max.	
Supply-Voltage Range (For $T_A =$ Full Package-Temperature Range)	—	3	18	V
Setup Time t_{SU} : Carry-In	5	200	—	ns
	10	70	—	
	15	60	—	
U/D or B/D	5	340	—	ns
	10	140	—	
	15	100	—	
Clock Pulse Width, t_W	5	180	—	ns
	10	90	—	
	15	60	—	
Preset Enable Pulse Width, t_W	5	130	—	ns
	10	70	—	
	15	50	—	
Clock Input Frequency, f_{CL}	5	—	2	MHz
	10	—	4	
	15	—	5.5	
Clock Rise and Fall Time, $t_{r,CL}$, $t_{f,CL}$	5	—	15	μ s
	10	—	15	
	15	—	15	

CD4029B Types

MAXIMUM RATINGS, Absolute-Maximum Values:

DC SUPPLY-VOLTAGE RANGE, (V _{DD})	-0.5V to +20V
Voltages referenced to V _{SS} Terminal)	
INPUT VOLTAGE RANGE, ALL INPUTS	-0.5V to V _{DD} +0.5V
DC INPUT CURRENT, ANY ONE INPUT	±10mA
POWER DISSIPATION PER PACKAGE (P _D):	
For T _A = -55°C to +100°C	500mW
For T _A = +100°C to +125°C	Derate Linearly at 12mW/°C to 200mW
DEVICE DISSIPATION PER OUTPUT TRANSISTOR	
FOR T _A = FULL PACKAGE-TEMPERATURE RANGE (All Package Types)	100mW
OPERATING-TEMPERATURE RANGE (T _A)	-55°C to +125°C
STORAGE TEMPERATURE RANGE (T _{stg})	-65°C to +150°C
LEAD TEMPERATURE (DURING SOLDERING):	
At distance 1/16 ± 1/32 inch (1.59 ± 0.79mm) from case for 10s max	+265°C

STATIC ELECTRICAL CHARACTERISTICS

CHARACTERISTIC	CONDITIONS			LIMITS AT INDICATED TEMPERATURES (°C)							UNITS
	V _O (V)	V _{IN} (V)	V _{DD} (V)	-55	-40	+85	+125	+25			
								Min.	Typ.	Max.	
Quiescent Device Current, I _{DD} Max.	-	0.5	5	5	5	150	150	-	0.04	5	μA
	-	0.10	10	10	10	300	300	-	0.04	10	
	-	0.15	15	20	20	600	600	-	0.04	20	
	-	0.20	20	100	100	3000	3000	-	0.08	100	
Output Low (Sink) Current I _{OL} Min.	0.4	0.5	5	0.64	0.61	0.42	0.36	0.51	1	-	mA
	0.5	0.10	10	1.6	1.5	1.1	0.9	1.3	2.6	-	
	1.5	0.15	15	4.2	4	2.8	2.4	3.4	6.8	-	
Output High (Source) Current, I _{OH} Min.	4.6	0.5	5	-0.64	-0.61	-0.42	-0.36	-0.51	-1	-	mA
	2.5	0.5	5	-2	-1.8	-1.3	-1.15	-1.6	-3.2	-	
	9.5	0.10	10	-1.6	-1.5	-1.1	-0.9	-1.3	-2.6	-	
	13.5	0.15	15	-4.2	-4	-2.8	-2.4	-3.4	-6.8	-	
Output Voltage: Low-Level, V _{OL} Max.	-	0.5	5	0.05				-	0	0.05	V
	-	0.10	10	0.05				-	0	0.05	
	-	0.15	15	0.05				-	0	0.05	
Output Voltage: High-Level, V _{OH} Min.	-	0.5	5	4.95				4.95	5	-	V
	-	0.10	10	9.95				9.95	10	-	
	-	0.15	15	14.95				14.95	15	-	
Input Low Voltage V _{IL} Max.	0.5, 4.5	-	5	1.5				-	-	1.5	V
	1.9	-	10	3				-	-	3	
	1.5, 13.5	-	15	4				-	-	4	
Input High Voltage, V _{IH} Min.	0.5, 4.5	-	5	3.5				3.5	-	-	V
	1.9	-	10	7				7	-	-	
	1.5, 13.5	-	15	11				11	-	-	
Input Current I _{IN} Max.	-	0.18	18	±0.1	±0.1	±1	±1	-	±10 ⁻⁵	±0.1	μA

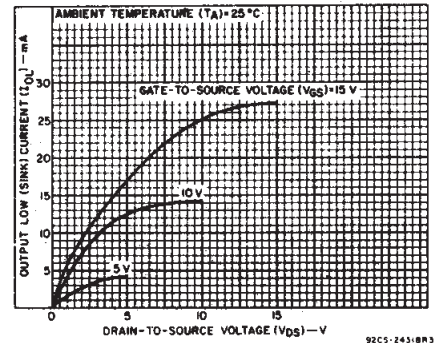

Fig. 1 - Typical output low (sink) current characteristics.

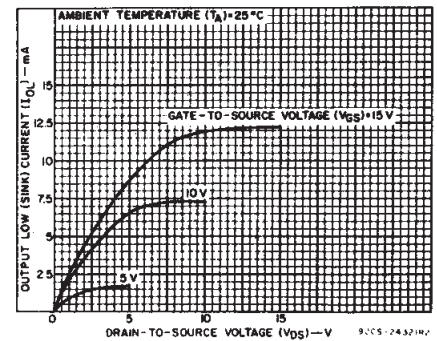

Fig. 2 - Minimum output low (sink) current characteristics.

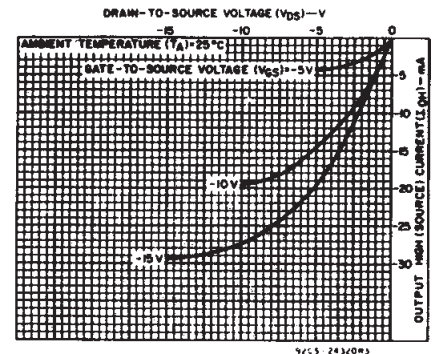

Fig. 3 - Typical output high (source) current characteristics.

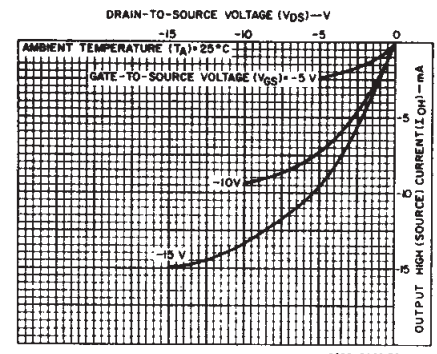

Fig. 4 - Minimum output high (source) current characteristics.

3
COMMERCIAL CMOS
HIGH VOLTAGE ICs

CD4029B Types

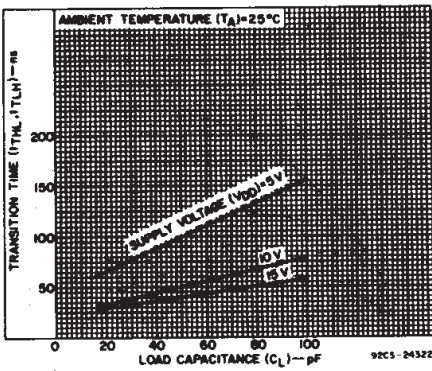

Fig. 5 - Typical transition time as a function of load capacitance.

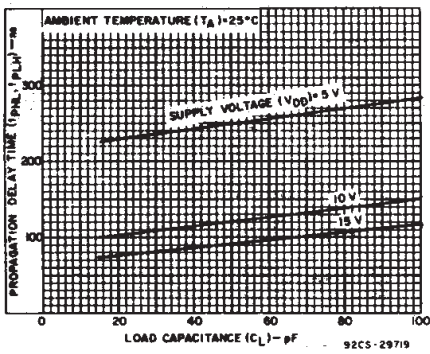

Fig. 6 - Typical propagation delay times as a function of load capacitance (Q output).

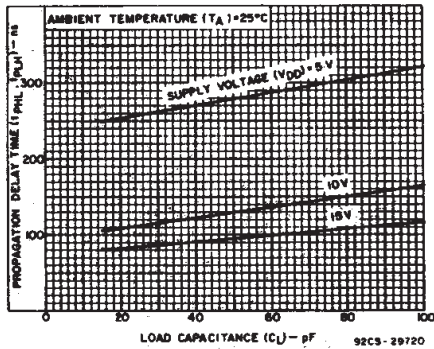

Fig. 7 - Typical propagation delay time as a function of load capacitance (carry output).

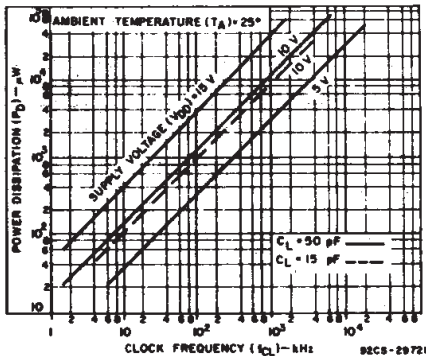
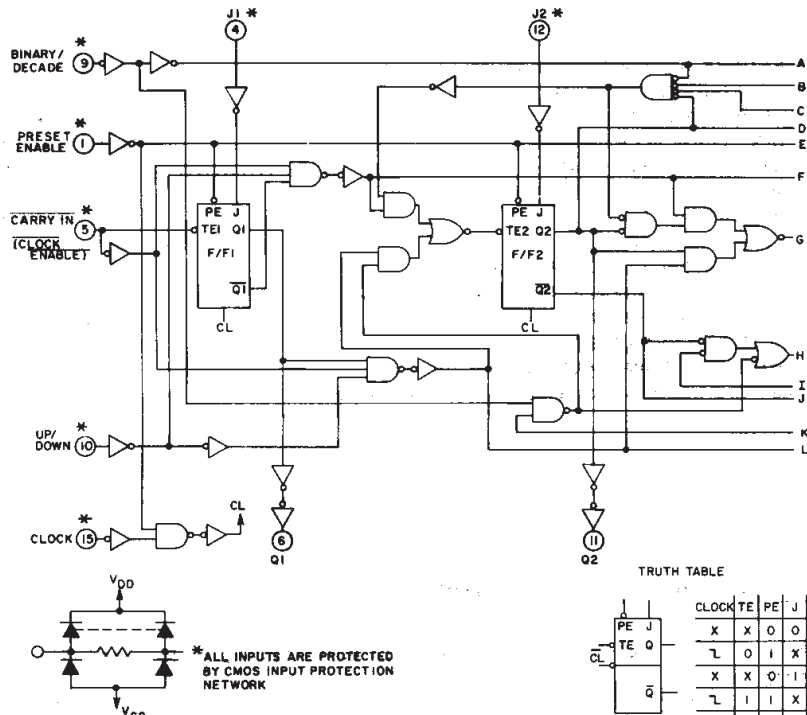

Fig. 8 - Typical power dissipation as a function of frequency.



TRUTH TABLE

CLOCK	TE	PE	J	Q	\bar{Q}
X	X	0	0	0	1
L	0	1	X	0	Q
X	X	0	1	1	0
L	1	1	X	Q	\bar{Q} NC
L	X	1	X	Q	\bar{Q} NC

X - DON'T CARE

92CL-28675R1

Fig. 9 - Logic diagram.

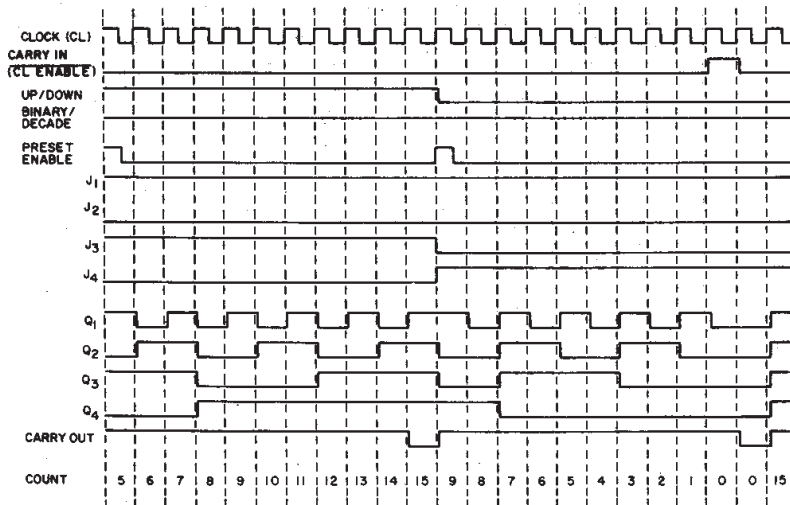
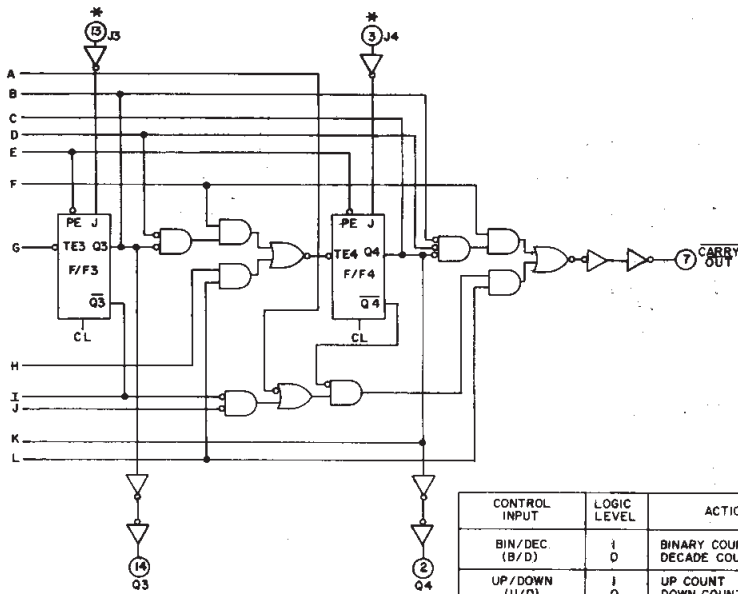

Fig. 10 - Timing diagram-binary mode.

92CM-17192R2

CD4029B Types



CONTROL INPUT	LOGIC LEVEL	ACTION
BIN/DEC. (B/D)	1	BINARY COUNT
	0	DECADE COUNT
UP/DOWN (U/D)	1	UP COUNT
	0	DOWN COUNT
PRESET ENABLE (PE)	1	JAM IN
	0	NO JAM
CARRY IN (CI) (CLOCK ENABLE)	1	NO COUNTER ADVANCE AT POS. CLOCK TRANSITION
	0	ADVANCE COUNTER AT POS. CLOCK TRANSITION

92CL-28675 R1

Fig. 9 – Logic diagram (cont'd).

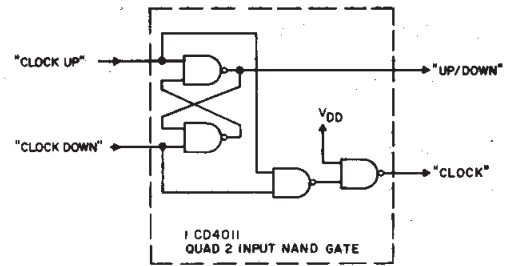

92CS-17195R2

Fig. 11 – Conversion of clock up, clock down input signals to clock and up/down input signals.

The CD4029B CLOCK and UP/DOWN inputs are used directly in most applications. In applications where CLOCK UP and CLOCK DOWN inputs are provided, conversion to the CD4029B CLOCK and UP/DOWN inputs can easily be realized by use of the circuit in Fig. 11.

CD4029B changes count on positive transitions of CLOCK UP or CLOCK DOWN inputs. For the gate configuration shown below, when counting up the CLOCK DOWN input must be maintained high and conversely when counting down the CLOCK UP input must be maintained high.

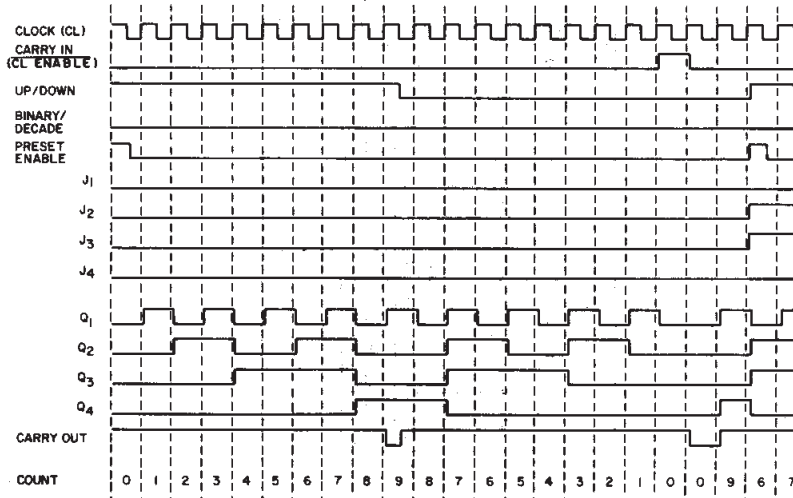

92CM-17193R3

Fig. 12 – Timing diagram-decade mode.

3
COMMERCIAL CMOS
HIGH VOLTAGE ICs

CD4029B Types

DYNAMIC ELECTRICAL CHARACTERISTICS at $T_A = 25^\circ\text{C}$, Input $t_r, t_f = 20\text{ ns}$, $C_L = 50\text{ pF}$, $R_L = 200\text{ k}\Omega$

CHARACTERISTIC	TEST CONDITIONS	LIMITS			UNITS	
		V_{DD} (V)	Min.	Typ.		Max.
Clocked Operation						
Propagation Delay Time: t_{PHL}, t_{PLH} Q Output		5	—	250	500	ns
		10	—	120	240	
		15	—	90	180	
Carry Output		5	—	280	560	
		10	—	130	260	
		15	—	95	190	
Transition Time: t_{THL}, t_{TLH} Q Outputs, Carry Output		5	—	100	200	
		10	—	50	100	
		15	—	40	80	
Minimum Clock Pulse Width, t_W		5	—	90	180	
		10	—	45	90	
		15	—	30	60	
Clock Rise & Fall Time, t_{rCL}, t_{fCL}^{**}		5	—	—	15	μs
		10	—	—	15	
		15	—	—	15	
Minimum Setup Times, t_S^* B/D or U/D		5	—	170	340	ns
		10	—	70	140	
		15	—	50	100	
Maximum Clock Input Frequency, f_{CL}		5	2	4	—	MHz
		10	4	8	—	
		15	5.5	11	—	
Input Capacitance, C_{IN}	Any Input	—	5	7.5	pF	
Preset Enable						
Propagation Delay Time: t_{PHL}, t_{PLH} Q Outputs		5	—	235	470	ns
		10	—	100	200	
		15	—	80	160	
Carry Output		5	—	320	640	
		10	—	145	290	
		15	—	105	210	
Minimum Preset Enable Pulse Width, t_W		5	—	65	130	
		10	—	35	70	
		15	—	25	50	
Minimum Preset Enable Removal Time, t_{rem}^*		5	—	100	200	
		10	—	55	110	
		15	—	40	80	
Carry Input						
Propagation Delay Time: t_{PHL}, t_{PLH} Carry Output		5	—	170	340	ns
		10	—	70	140	
		15	—	50	100	
Min. HOLD Time t_H^{***} Carry In		5	—	25	50	ns
		10	—	15	30	
		15	—	12	25	
Min Set-Up Time t_S^{***} Carry In		5	—	100	200	ns
		10	—	35	70	
		15	—	30	60	

* From Up/Down, Binary/Decode, Carry In, or Preset Enable Control Inputs to Clock Edge.

** If more than one unit is cascaded in the parallel clocked application, t_{rCL} should be made less than or equal to the sum of the fixed propagation delay at 15 pF and the transition time of the carry output driving stage for the estimated capacitive load. This measurement was made with a decoupling capacitor ($>1\text{ }\mu\text{F}$) between V_{DD} and V_{SS} .

*** From Carry In to Clock Edge

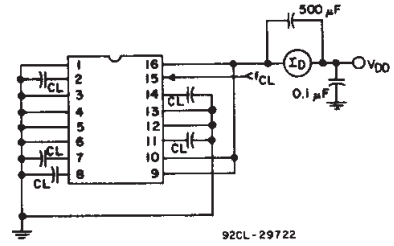

Fig. 13 — Power dissipation test circuit.

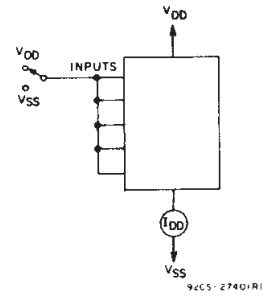

Fig. 14 — Quiescent device current test circuit.

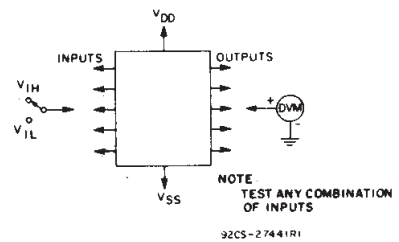

Fig. 15 — Input voltage test circuit.

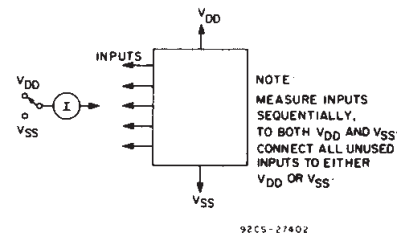
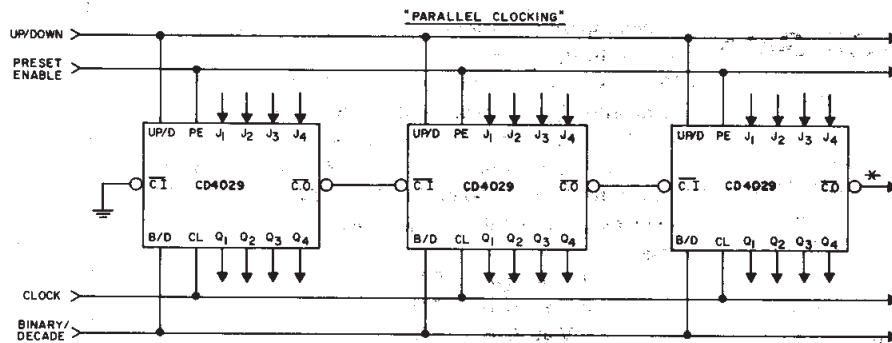
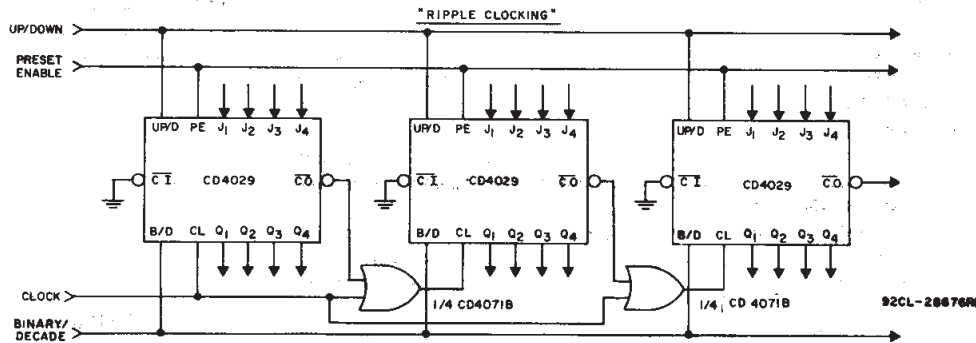

Fig. 16 — Input current test circuit.

CD4029B Types



* CARRY OUT lines at the 2nd, 3rd, etc., stages may have a negative-going glitch pulse resulting from differential delays of different CD4029B IC's. These negative-going glitches do not affect proper CD4029B operation. However, if the CARRY OUT signals are used to trigger other edge-sensitive logic devices, such as FF's or counters, the CARRY OUT signals should be gated with the clock signal using a 2-input OR gate such as CD4071B.



Ripple Clocking Mode:
The Up/Down control can be changed at any count. The only restriction on changing the Up/Down control is that the clock input to the first counting stage must be high. For cascading counters operating in a fixed up-count or down-count mode, the OR gates are not required between stages, and CO is connected directly to the CL input of the next stage with CI grounded.

Fig. 17 - Cascading counter packages.

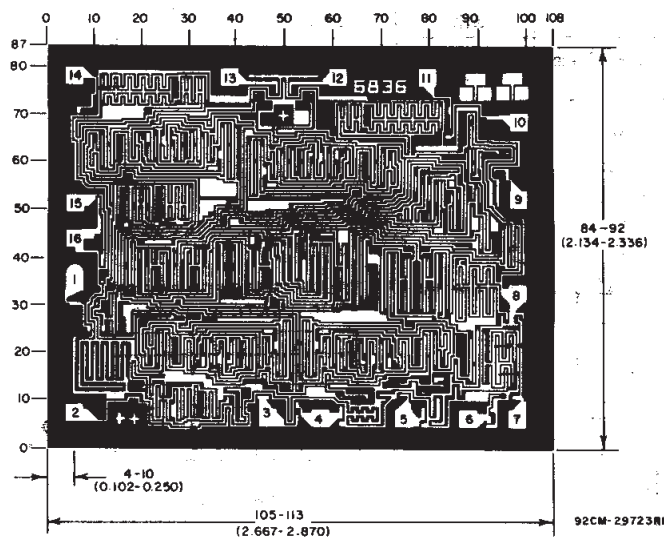

Chip dimensions and pad layout for CD4029B

Dimensions in parentheses are in millimeters and are derived from the basic inch dimensions as indicated. Grid graduations are in mils (10^{-3} inch).

3
COMMERCIAL CMOS
HIGH VOLTAGE ICs

IMPORTANT NOTICE

Texas Instruments and its subsidiaries (TI) reserve the right to make changes to their products or to discontinue any product or service without notice, and advise customers to obtain the latest version of relevant information to verify, before placing orders, that information being relied on is current and complete. All products are sold subject to the terms and conditions of sale supplied at the time of order acknowledgement, including those pertaining to warranty, patent infringement, and limitation of liability.

TI warrants performance of its semiconductor products to the specifications applicable at the time of sale in accordance with TI's standard warranty. Testing and other quality control techniques are utilized to the extent TI deems necessary to support this warranty. Specific testing of all parameters of each device is not necessarily performed, except those mandated by government requirements.

CERTAIN APPLICATIONS USING SEMICONDUCTOR PRODUCTS MAY INVOLVE POTENTIAL RISKS OF DEATH, PERSONAL INJURY, OR SEVERE PROPERTY OR ENVIRONMENTAL DAMAGE ("CRITICAL APPLICATIONS"). TI SEMICONDUCTOR PRODUCTS ARE NOT DESIGNED, AUTHORIZED, OR WARRANTED TO BE SUITABLE FOR USE IN LIFE-SUPPORT DEVICES OR SYSTEMS OR OTHER CRITICAL APPLICATIONS. INCLUSION OF TI PRODUCTS IN SUCH APPLICATIONS IS UNDERSTOOD TO BE FULLY AT THE CUSTOMER'S RISK.

In order to minimize risks associated with the customer's applications, adequate design and operating safeguards must be provided by the customer to minimize inherent or procedural hazards.

TI assumes no liability for applications assistance or customer product design. TI does not warrant or represent that any license, either express or implied, is granted under any patent right, copyright, mask work right, or other intellectual property right of TI covering or relating to any combination, machine, or process in which such semiconductor products or services might be or are used. TI's publication of information regarding any third party's products or services does not constitute TI's approval, warranty or endorsement thereof.