

Hyperfast Rectifier

Features

- Hyperfast Recovery Time
- Low Forward Voltage Drop
- Low Leakage Current
- 175°C Operating Junction Temperature
- Fully Isolated package ($V_{INS} = 2500 V_{RMS}$)
- UL E78996 approved 

$t_{rr} = 22ns$ typ.
 $I_{F(AV)} = 15Amp$
 $V_R = 600V$

Description/ Applications

State of the art Hyperfast recovery rectifiers designed with optimized performance of forward voltage drop, Hyperfast recover time, and soft recovery. The planar structure and the platinum doped life time control guarantee the best overall performance, ruggedness and reliability characteristics. These devices are intended for use in PFC Boost stage in the AC-DC section of SMPS, inverters or as freewheeling diodes. The IR extremely optimized stored charge and low recovery current minimize the switching losses and reduce over dissipation in the switching element and snubbers.

Absolute Maximum Ratings

Parameters		Max	Units
V_{RRM}	Peak Repetitive Peak Reverse Voltage	600	V
$I_{F(AV)}$	Average Rectified Forward Current @ $T_C = 80^\circ C$	15	A
I_{FSM}	Non Repetitive Peak Surge Current @ $T_J = 25^\circ C$	180	
I_{FM}	Peak Repetitive Forward Current	30	
T_J, T_{STG}	Operating Junction and Storage Temperatures - 65 to 175	$^\circ C$	

Case Styles

15ETH06FP

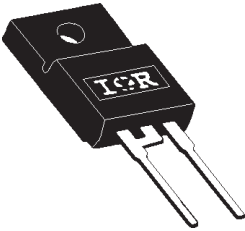
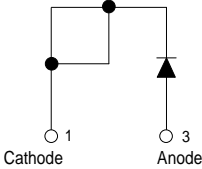
TO-220 FULLPACK

Electrical Characteristics @ T_J = 25°C (unless otherwise specified)

Parameters	Min	Typ	Max	Units	Test Conditions
V _{BR} , V _r Breakdown Voltage, Blocking Voltage	600	-	-	V	I _R = 100μA
V _F Forward Voltage	-	1.8	2.2	V	I _F = 15A, T _J = 25°C
	-	1.3	1.6	V	I _F = 15A, T _J = 150°C
I _R Reverse Leakage Current	-	0.2	50	μA	V _R = V _R Rated
	-	30	500	μA	T _J = 150°C, V _R = V _R Rated
C _T Junction Capacitance	-	20	-	pF	V _R = 600V
L _S Series Inductance	-	8.0	-	nH	Measured lead to lead 5mm from package body

Dynamic Recovery Characteristics @ T_C = 25°C (unless otherwise specified)

Parameters	Min	Typ	Max	Units	Test Conditions	
t _{rr} Reverse Recovery Time	-	22	30	ns	I _F = 1A, di _F /dt = 100A/μs, V _R = 30V	
	-	28	35		I _F = 15A, di _F /dt = 100A/μs, V _R = 30V	
	-	29	-	ns	T _J = 25°C	
	-	75	-		T _J = 125°C	
I _{RRM} Peak Recovery Current	-	3.5	-	A	T _J = 25°C	
	-	7	-		T _J = 125°C	
Q _{rr} Reverse Recovery Charge	-	57	-	nC	T _J = 25°C	
	-	300	-		T _J = 125°C	
t _{rr} Reverse Recovery Time	-	51	-	ns	T _J = 125°C I _F = 15A di _F /dt = 800A/μs V _R = 390V	
I _{RRM} Peak Recovery Current	-	20	-			A
Q _{rr} Reverse Recovery Charge	-	580	-			nC

Thermal - Mechanical Characteristics

Parameters	Min	Typ	Max	Units
T _J Max. Junction Temperature Range	-	-	175	°C
T _{Stg} Max. Storage Temperature Range	-65	-	175	
R _{thJC} Thermal Resistance, Junction to Case Per Leg	-	3.0	3.5	°C/W
R _{thJA} ① Thermal Resistance, Junction to Ambient Per Leg	-	-	70	
R _{thCS} ② Thermal Resistance, Case to Heatsink	-	0.5	-	
Weight	-	2.0	-	g
	-	0.07	-	(oz)
Mounting Torque	6.0	-	12	Kg-cm
	5.0	-	10	lbf.in

① Typical Socket Mount

② Mounting Surface, Flat, Smooth and Greased

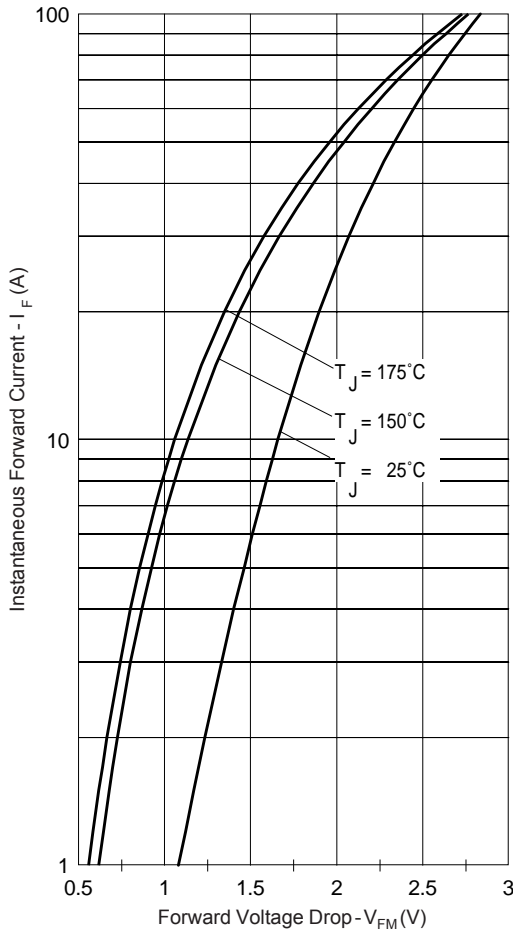

Fig. 1 - Typical Forward Voltage Drop Characteristics

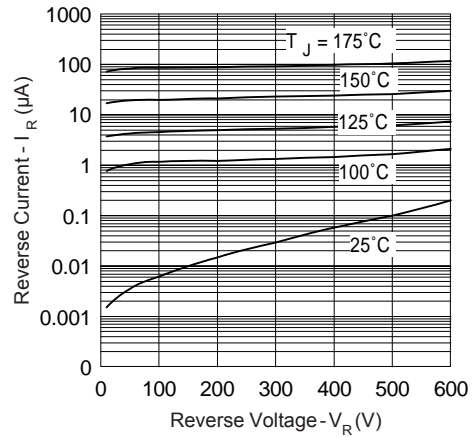

Fig. 2 - Typical Values Of Reverse Current Vs. Reverse Voltage

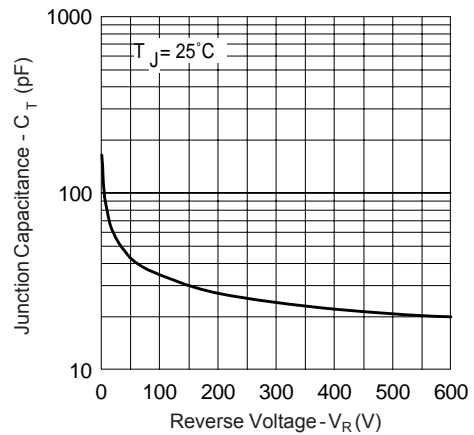

Fig. 3 - Typical Junction Capacitance Vs. Reverse Voltage

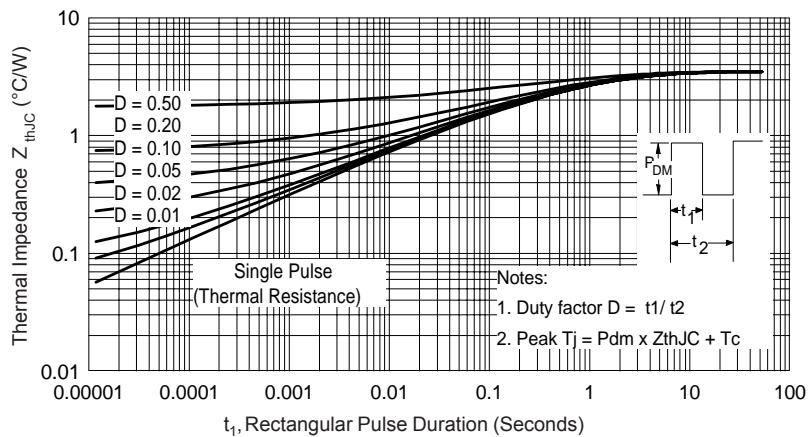

Fig. 4 - Max. Thermal Impedance Z_{thjC} Characteristics

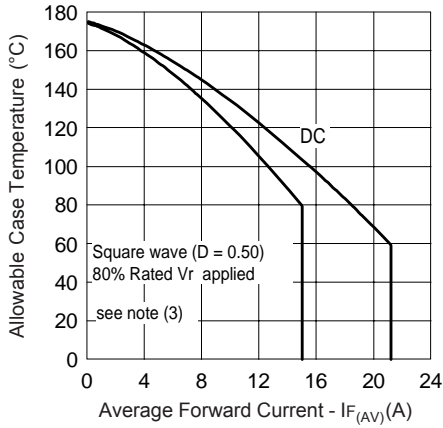

Fig. 5 - Max. Allowable Case Temperature Vs. Average Forward Current

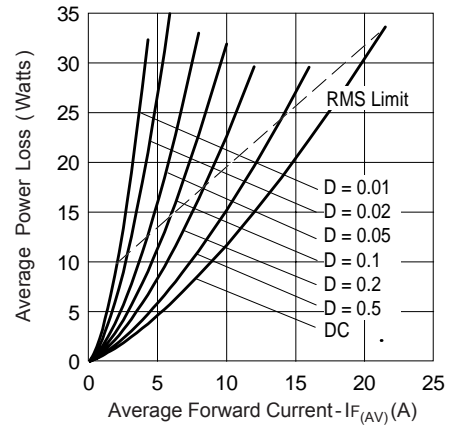

Fig. 6 - Forward Power Loss Characteristics

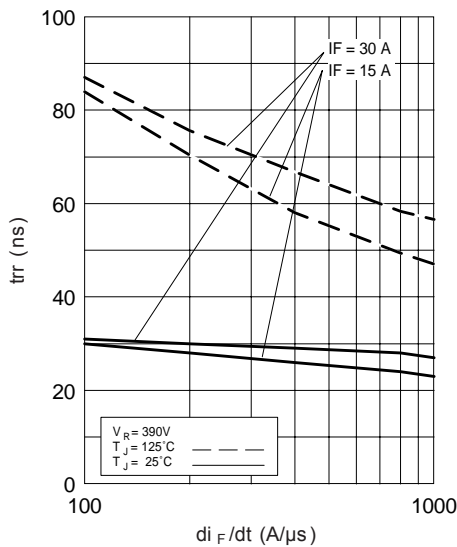

Fig. 7 - Typical Reverse Recovery vs. di_F/dt

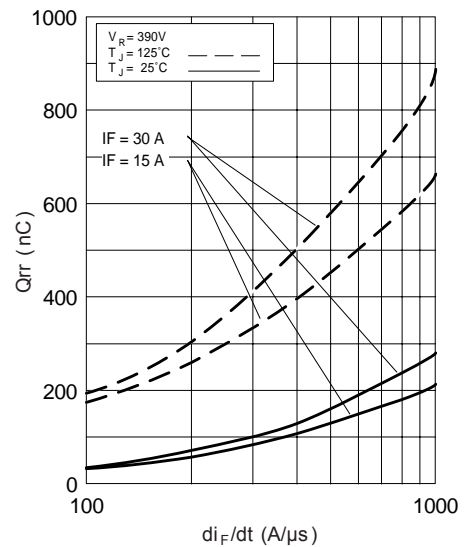

Fig. 8 - Typical Stored Charge vs. di_F/dt

(3) Formula used: $T_c = T_j - (Pd + Pd_{REV}) \times R_{thJC}$;
 $Pd = \text{Forward Power Loss} = I_{F(AV)} \times V_{FM} @ (I_{F(AV)} / D)$ (see Fig. 6);
 $Pd_{REV} = \text{Inverse Power Loss} = V_{R1} \times I_{R1} (1 - D)$; $I_{R1} @ V_{R1} = \text{rated } V_R$

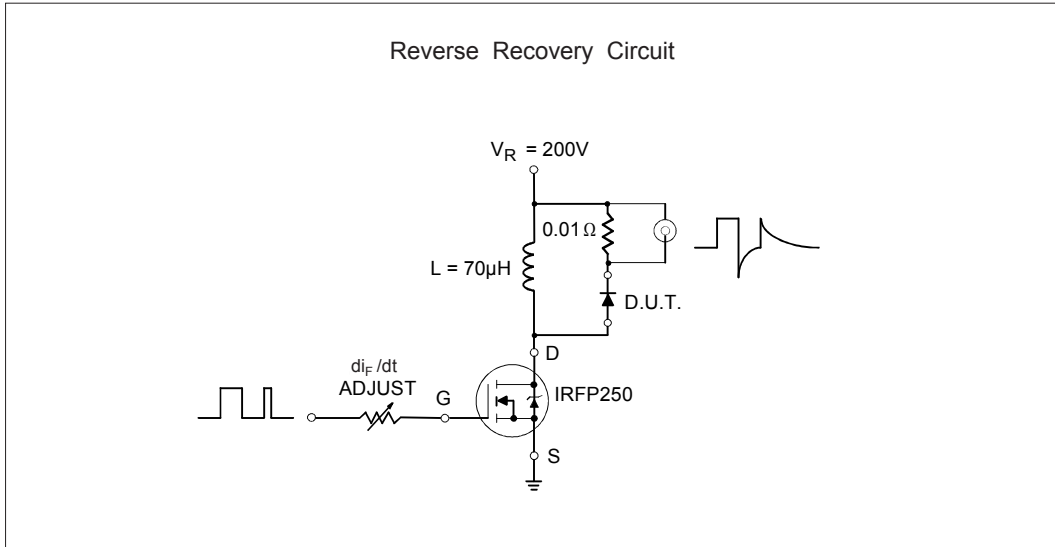

Fig. 9- Reverse Recovery Parameter Test Circuit

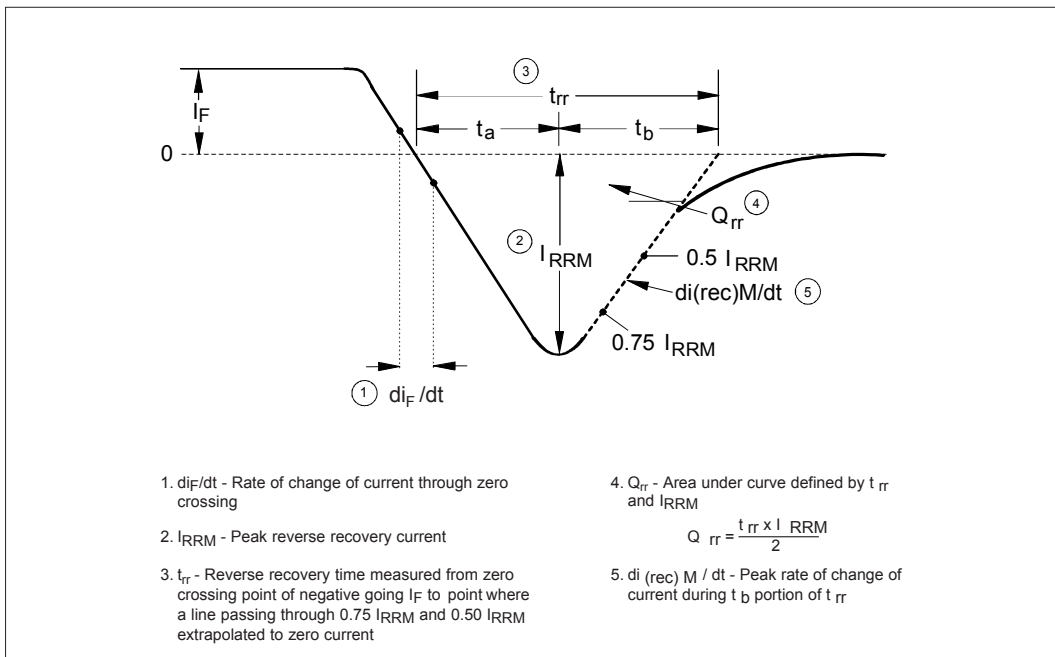
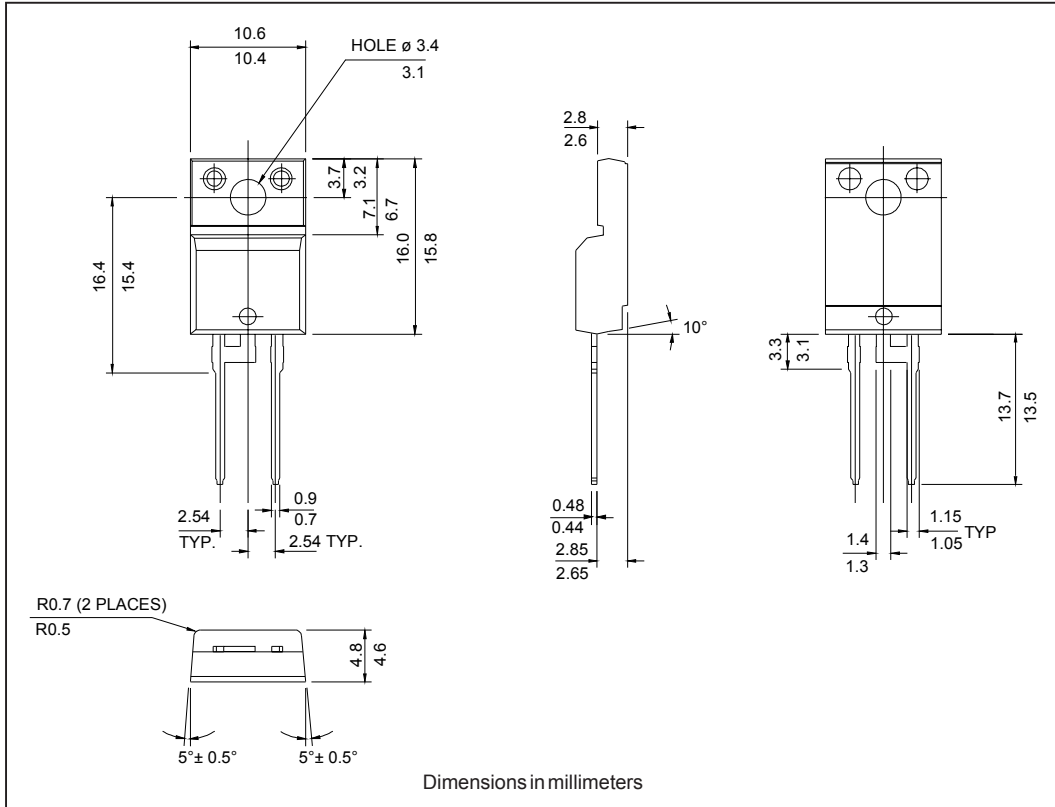

Fig. 10 - Reverse Recovery Waveform and Definitions

Outline Table



Ordering Information Table

Device Code					
15	E	T	H	06	FP
①	②	③	④	⑤	⑥
1	-	Current Rating (15 = 15A)			
2	-	E = Single Diode			
3	-	T = TO-220			
4	-	H = HyperFast Recovery			
5	-	Voltage Rating (06 = 600V)			
6	-	TO-220 FULLPACK			

Data and specifications subject to change without notice.
This product has been designed and qualified for Industrial Level.
Qualification Standards can be found on IR's Web site.

International
IOR Rectifier

IR WORLD HEADQUARTERS: 233 Kansas St., El Segundo, California 90245, USA Tel: (310) 252-7105
TAC Fax: (310) 252-7309
Visit us at www.irf.com for sales contact information. 02/04